

# S.M.T.A | 2024

*Chauffage & Sanitaire* *Maï*



☎ 01 48 60 66 84  
09 54 48 62 44

📄 01 48 60 66 84  
09 54 48 62 44

✉ [infos@societe-smta.fr](mailto:infos@societe-smta.fr)  
🌐 [www.societe-smta.fr](http://www.societe-smta.fr)

# TABLE DE FACTEURS DE CORRECTION

EN442  $\Delta T 50^{\circ}\text{C}$  75/65/20

	T°C d'arrivée d'eau	T°C ambiante souhaitée												
		25	30	35	40	45	50	55	60	65	70	75	80	85
90	26	2,96	2,11	1,72	1,47	1,30	1,17	1,07	0,98	0,91	0,86	0,81	0,76	
	24	4,56	2,45	1,88	1,57	1,36	1,21	1,10	1,01	0,93	0,87	0,82	0,77	0,73
	22	3,11	2,11	1,69	1,44	1,27	1,14	1,04	0,96	0,89	0,83	0,78	0,74	0,70
	20	2,50	1,87	1,54	1,33	1,19	1,07	0,98	0,91	0,85	0,80	0,75	0,71	0,67
	18	2,13	1,68	1,42	1,24	1,11	1,01	0,93	0,87	0,81	0,76	0,72	0,68	0,65
	15	1,76	1,46	1,26	1,13	1,02	0,93	0,87	0,81	0,76	0,72	0,68	0,64	0,61
85	26	3,19	2,26	1,83	1,57	1,38	1,24	1,13	1,04	0,97	0,90	0,85		
	24	4,94	2,63	2,00	1,67	1,45	1,29	1,16	1,07	0,99	0,92	0,86	0,81	
	22	3,34	2,26	1,80	1,53	1,34	1,21	1,10	1,01	0,94	0,88	0,82	0,78	
	20	2,67	1,99	1,64	1,41	1,25	1,13	1,04	0,96	0,89	0,84	0,79	0,75	
	18	2,27	1,78	1,50	1,31	1,18	1,07	0,98	0,91	0,85	0,80	0,75	0,72	
	15	1,87	1,54	1,33	1,19	1,07	0,98	0,91	0,85	0,80	0,75	0,71	0,67	
80	26	3,45	2,44	1,97	1,68	1,47	1,32	1,20	1,11	1,03	0,96			
	24	5,38	2,83	2,15	1,78	1,54	1,37	1,24	1,13	1,05	0,97	0,91		
	22	3,61	2,42	1,93	1,63	1,43	1,28	1,16	1,07	0,99	0,93	0,87		
	20	2,87	2,13	1,75	1,50	1,33	1,20	1,10	1,01	0,94	0,88	0,83		
	18	2,42	1,90	1,60	1,39	1,24	1,13	1,04	0,96	0,90	0,84	0,79		
	15	1,99	1,64	1,41	1,25	1,13	1,04	0,96	0,89	0,84	0,79	0,75		
75	26	3,77	2,64	2,12	1,80	1,58	1,42	1,29	1,18	1,10				
	24	5,90	3,07	2,32	1,92	1,66	1,47	1,32	1,21	1,12	1,04			
	22	3,92	2,61	2,07	1,75	1,53	1,37	1,24	1,14	1,05	0,98			
	20	3,10	2,28	1,87	1,61	1,42	1,28	1,17	1,08	1,00	0,94			
	18	2,61	2,03	1,70	1,48	1,32	1,20	1,10	1,02	0,95	0,89			
	15	2,13	1,75	1,50	1,33	1,20	1,10	1,01	0,94	0,88	0,83			
70	26	4,15	2,89	2,31	1,95	1,71	1,53	1,39	1,27					
	24	6,54	3,36	2,52	2,08	1,79	1,58	1,42	1,30	1,19				
	22	4,30	2,84	2,24	1,89	1,64	1,47	1,33	1,22	1,13				
	20	3,38	2,47	2,02	1,73	1,52	1,37	1,25	1,15	1,07				
	18	2,82	2,19	1,83	1,59	1,42	1,28	1,17	1,08	1,01				
	15	2,28	1,87	1,61	1,42	1,28	1,17	1,08	1,00	0,94				
65	26	4,61	3,18	2,53	2,13	1,86	1,66	1,50						
	24	7,33	3,70	2,76	2,27	1,94	1,71	1,54	1,40					
	22	4,75	3,11	2,44	2,05	1,78	1,59	1,43	1,31					
	20	3,70	2,69	2,19	1,87	1,64	1,47	1,34	1,23					
	18	3,07	2,37	1,98	1,71	1,52	1,37	1,26	1,16					
	15	2,47	2,02	1,73	1,52	1,37	1,25	1,15	1,07					
60	26	5,20	3,55	2,80	2,36	2,05	1,82							
	24	8,32	4,13	3,06	2,50	2,13	1,87	1,68						
	22	5,32	3,44	2,69	2,24	1,94	1,73	1,56						
	20	4,10	2,96	2,39	2,03	1,78	1,60	1,45						
	18	3,38	2,59	2,15	1,86	1,65	1,48	1,36						
	15	2,69	2,19	1,87	1,64	1,47	1,34	1,23						
55	26	5,96	4,02	3,15	2,64	2,28								
	24	9,62	4,67	3,43	2,78	2,37	2,07							
	22	6,03	3,86	2,99	2,48	2,15	1,90							
	20	4,60	3,29	2,64	2,24	1,96	1,75							
	18	3,75	2,86	2,36	2,03	1,80	1,62							
	15	2,96	2,39	2,03	1,78	1,60	1,45							
50	26	6,99	4,64	3,61	3,00									
	24	11,38	5,39	3,92	3,15	2,67								
	22	6,97	4,39	3,38	2,79	2,40								
	20	5,23	3,70	2,96	2,50	2,17								
	18	4,22	3,20	2,63	2,25	1,98								
	15	3,29	2,64	2,24	1,96	1,75								
45	26	8,48	5,52	4,25										
	24	13,93	6,38	4,58	3,66									
	22	8,26	5,11	3,89	3,19									
	20	6,08	4,25	3,37	2,83									
	18	4,84	3,63	2,96	2,53									
	15	3,70	2,96	2,50	2,17									
40	26	10,81	6,87											
	24	17,93	7,87	5,54										
	22	10,17	6,14	4,62										
	20	7,28	5,01	3,93										
	18	5,68	4,21	3,41										
	15	4,25	3,37	2,83										
35	26	15,13												
	24	25,15	10,36											
	22	13,27	7,77											
	20	9,12	6,14											
	18	6,91	5,04											
	15	5,01	3,93											

## ATTENTION

Les facteurs de correction sont indicatifs, car déterminés en utilisant une pente moyenne de 1,3.

Exemple:

Vous cherchez un radiateur de 1000 Watts selon le régime 80/60/22. Il faut d'abord déterminer la puissance correspondante en 75/65/20, ce qui permet de sélectionner le radiateur dans le tableau de puissance.

Procédez de façon suivante:

1. Cherchez le facteur de correction qui correspond à une température d'arrivée d'eau de 80°C, une température de retour de 60°C et une température de ambiante souhaité de 22°C.
2. Multipliez la puissance désirée en 80/60/22 par le facteur de correction :  $1000 \times 1,07 = 1070\text{W}$ . Ceci représente la puissance correspondante en 75/65/20.
3. Sélectionnez un radiateur de 1070 watt dans le tableau de puissances. Ce radiateur aura une puissance de 1000 watt en 80/60/22

# SOMMAIRE

## SANITAIRE

Receveur de douche	5
Pare-douche	6
Receveur Naturals	7
Robinetterie de douche	8
Pare-bain	9
Parois de douche	10 - 11
Baignoire & Toilette WC	12
Meuble de salle de bain	13
Robinetterie & vidage	14
Vasque	15

## ELECTRIQUE

Les kits mixtes	17
CAPRI	18
E-CLASSICO	19

## CHAUFFAGE

KOMPACT Horizontal	21 - 25
KOMPACT Vertical	26 - 27
K-FLAT & LINEAR	28 - 29
Multicolonne RONDO	30 - 31
HERITAGE	32
RENAISSANCE	33
FLOREAL	34
MAGNO	36
PIEVE & ALBA	37
CLASSICO 22	38 - 39
Robinetterie	40 - 41
Climatisation	42 - 43

## Legende des pictogrammes



Produit stocké directement par le fabricant ou le distributeur



Produit disponible en couleur suivant nuancier



Produit compatible pour utilisation eau ou vapeur sous respect des conditions maximales d'utilisation



Traitement anti-bacterien



Produit non peint Fourni en peinture d'apprêt Nécessite une peinture de finition



Système de rinçage sans bride

Produit conforme aux normes



EN215



IP 24 CLASSE II

Indice de protection élevé Protection IP24



\*\*\* EURONORM ENI 442

Nos prix s'entendent hors TVA et sont donnés à titre indicatif.  
S.M.T.A. se réserve le droit à toute révision tarifaire durant l'année en cours.

SANITAIRE

K·VIT





# Receveur de douche

## K·VIT

SANITAIRE



Autres tailles disponibles sur demande



Kit de pied et plinthe

### Version antidérapante

#### Receveur Carré

800mm AST800S	<b>211 €</b>
900mm AST900S	<b>232 €</b>

#### Receveur Rectangulaire

1000 x 700mm AST1070R	<b>317 €</b>	1100 x 900mm AST1090R	<b>402 €</b>
1000 x 800mm AST1080R	<b>356 €</b>	1200 x 700mm AST1270R	<b>383 €</b>
1000 x 900mm AST1090R	<b>391 €</b>	1200 x 800mm AST1280R	<b>383 €</b>
1100 x 800mm AST1180R	<b>396 €</b>	1200 x 900mm AST1290R	<b>396 €</b>

#### Receveur Quart de rond

900mm AST900Q	<b>283 €</b>
------------------	--------------

Pour receveur 1/4 de rond symétrique

JTKQ **121 €**

Pour receveur 1/4 de rond asymétrique

JTKOS **121 €**

Pour receveur Carré / Rectangle

De 700mm à 1200mm

JTKSR **121 €**

De 1300mm à 1800mm

JTKSR1800 **146 €**



### Version classique

#### Receveur Rectangulaire

900 x 700mm KRR0907L	<b>247 €</b>	1100 x 800mm KRR1108L	<b>315 €</b>
900 x 800mm KRR0908L	<b>247 €</b>	1100 x 900mm KRR1109L	<b>315 €</b>
1000 x 700mm KRR1007L	<b>247 €</b>	1200 x 700mm KRR1207L	<b>306 €</b>
1000 x 800mm KRR1008L	<b>282 €</b>	1200 x 800mm KRR1208L	<b>287 €</b>
1000 x 900mm KRR1009L	<b>298 €</b>	1200 x 900mm KRR1209L	<b>306 €</b>

#### Receveur Carré

700mm KRS0707L	<b>188 €</b>
800mm KRS0808L	<b>196 €</b>

#### Receveur Quart de rond

900mm KRS0909L	<b>233 €</b>	800mm KRQ0808L	<b>212 €</b>
1000mm KRS1010L	<b>350 €</b>	900mm KRQ0909L	<b>222 €</b>
		1000mm KRQ1010L	<b>338 €</b>

!! Bonde de vidage vendue séparément



Bonde 90mm - Chromé  
FFW90 **16 €**



Bonde 90mm - Noir  
FFW90-BLACK **36 €**



Bonde 90mm - Laiton  
FFW90-BRASS **36 €**



### 3 Finitions au choix



Chromé



Noir Mat



Or Brossé

#### Pare-douche

##### 800mm

Réglable de 785 à 800mm

Chromé - EIGHT800W **336 €**

Noir Mat - EIGHT800W-N **409 €**

Or Brossé - EIGHT800W-O **441 €**

##### 900mm

Réglable de 885 à 900mm

Chromé - EIGHT900W **349 €**

Noir Mat - EIGHT900W-N **422 €**

Or Brossé - EIGHT900W-O **454 €**

##### 1000mm

Réglable de 985 à 1000mm

Chromé - EIGHT1000W **371 €**

Noir Mat - EIGHT1000W-N **444 €**

Or Brossé - EIGHT1000W-O **476 €**

##### 1200mm

Réglable de 1185 à 1200mm

Chromé - EIGHT1200W **396 €**

Noir Mat - EIGHT1200W-N **469 €**

Or Brossé - EIGHT1200W-O **501 €**

#### Panneau de retour

##### 300mm

Chromé - EIGHT300W **228 €**

Noir Mat - NER300W **228 €**

Or Brossé - EIGHT300B **239 €**

#### Mat de renfort

Chromé - 3 mètres

EIGHT201WP **103 €**



ROBINETTERIE DE DOUCHE  
VOIR PAGE 8

**Autres tailles disponibles sur demande.  
Finition verrière également disponible.**



# Receveur Naturals

## K·VIT

SANITAIRE



### NATURALS

Receveur de douche rectangulaire à effet pierre - Anthracite\*

1200 x 700mm STOR1207GP	<b>455 €</b>	1400 x 700mm STOR1407GP	<b>508 €</b>	1600 x 700mm STOR1607GP	<b>561 €</b>	1700 x 700mm STOR1707GP	<b>614 €</b>
1200 x 800mm STOR1208GP	<b>476 €</b>	1400 x 800mm STOR1408GP	<b>529 €</b>	1600 x 800mm STOR1608GP	<b>582 €</b>	1700 x 800mm STOR1708GP	<b>635 €</b>
1200 x 900mm STOR1209GP	<b>508 €</b>	1400 x 900mm STOR1409GP	<b>571 €</b>	1600 x 900mm STOR1609GP	<b>614 €</b>	1700 x 900mm STOR1709GP	<b>677 €</b>

\*Vendu de serie avec grille inox

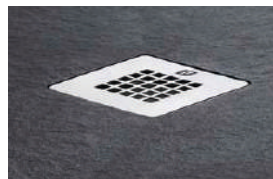

Grille inox - Chromé  
PDA-064

### ACCESSOIRES

A commander séparément



Bonde 90mm - Chromé  
FFW90 **16 €**

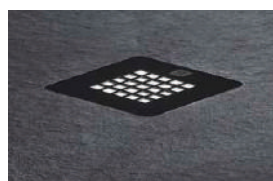

Grille inox - Anthracite  
PDA-064GP **37 €**

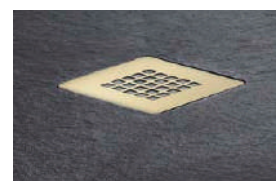

Grille inox - Or Brossé  
PDA-064BR **37 €**

# Robinetterie de douche

## K·VIT

STOCK EXPRESS

GARANTIE 5 ANS

3 COLORIS



Ensemble thermostatique  
PLAN 

Chromé  
SHO005PL **105 €**



Colonne thermostatique  
PLAN 

Chromé  
SHO007PL **211 €**



Colonne thermostatique  
NERO ROUND 

Noir Mat  
SHO052NR **265 €**



Colonne thermostatique  
OTTONE

Or Brossé  
SHO140OT **455 €**



Colonne thermostatique  
PURE 

Chromé  
SHO030PR **270 €**



Colonne thermostatique  
NERO SQUARE 

Noir Mat  
SHO050NS **339 €**



ROBINETTERIE ET ACCESSOIRES  
VOIR PAGE 14



GARANTIE  
25  
ANS

ALUMINIUM

HAUTEUR  
1400  
MM

VERRE  
6  
MM

PIVOTANT

# Pare-bain K·VIT

SANITAIRE



Bords arrondis

Pare-bain Chromé

1400 x 780mm

KONSSS - Bords droit

155 €

KONSS - Bords arrondis

155 €



Bords droits

Pare-bain Noir Mat

1400 x 780mm

NER-SSS - Bords droit

158 €

NER-SS - Bords arrondis

158 €



Pare-bain Verrière

1400 x 780mm - Noir Mat

KRI-SS

202 €

# Parois de douche

## K·VIT

GARANTIE  
25  
ANSPré-  
monté

ALUMINIUM

HAUTEUR  
1850  
MMVERRE  
6  
MMSTOCK  
EXPRESS

Autres tailles disponibles sur demande



Parois Pliables

700mm  
De 650 à 690mm  
SIX700BF **381 €**

800mm  
De 750 à 790mm  
SIX800BF **419 €**

900mm  
De 850 à 890mm  
SIX900BF **428 €**



Parois Quart de rond

800mm  
De 760 à 780mm  
6KON800Q **417 €**

900mm  
De 860 à 880mm  
6KON900Q **417 €**



Parois Coulissantes

1000mm  
De 950 à 990mm  
SIX1000SD **379 €**

1100mm  
De 1050 à 1090mm  
SIX1100SD **379 €**

1200mm  
De 1150 à 1190mm  
SIX1200SD **379 €**

Parois latérales fixes

700mm  
De 670 à 690mm  
SIX700SP **232 €**

800mm  
De 770 à 790mm  
SIX800SP **254 €**

900mm  
De 870 à 890mm  
SIX900SP **260 €**

Profilé de compensation +2cm  
2 profilés de 1 cm  
SIXEXT **94 €**



# Parois de douche

## K·VIT

SANITAIRE

Autres tailles disponibles sur demande



Parois Pivotantes

800mm	900mm
De 750 à 790mm	De 850 à 890mm
EIGHT800HD <b>403 €</b>	EIGHT900HD <b>413 €</b>



Parois Quart de rond

900mm
De 860 à 880mm
EIGHT900Q <b>519 €</b>

*Nouveau*

 VERRE  
8 mm  
QUALITE PREMIUM



Parois Coulissantes

1000mm
De 950 à 990mm
EIGHT1000SD <b>435 €</b>
1100mm
De 1050 à 1090mm
EIGHT1100SD <b>445 €</b>
1200mm
De 1150 à 1190mm
EIGHT1200SD <b>477 €</b>

Parois latérales fixes

700mm	800mm	900mm
De 670 à 690mm	De 770 à 790mm	De 870 à 890mm
EIGHT700SP <b>254 €</b>	EIGHT800SP <b>276 €</b>	EIGHT900SP <b>286 €</b>

# Baignoire & Toilette WC

- GARANTIE 5 ANS
- ACIER
- PIEDS INCLUS
- STOCK EXPRESS



Baignoire Acier émaillée  
Non Percée - Percée à Droite - Percée à Gauche

1000 x 700mm   
Non percée  
MB100NP **149 €**

1200 x 700mm   
Non percée  
MB120NP **149 €**

1200 x 700mm   
Percée à Droite  
MB120D **149 €**

1200 x 700mm   
Percée à Gauche  
MB120G **149 €**

1300 x 700mm   
Non percée  
MB130NP **149 €**

1300 x 700mm   
Percée à Droite  
MB130D **149 €**

1300 x 700mm   
Percée à Gauche  
MB130G **149 €**

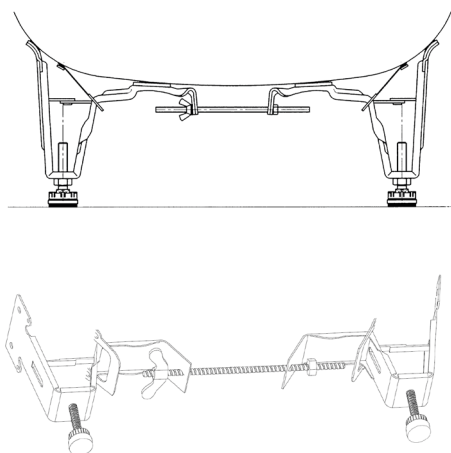
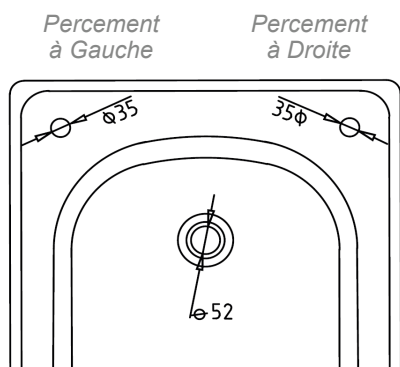

- GARANTIE 5 ANS
- CERAMIQUE
- PORCELAINE VITRIFIEE
- STOCK EXPRESS

Cuvette Suspendu ALPHA  
Abattant inclus

Cuvette WC   
L = 52 cm  
POT000AL **121 €**



- GARANTIE 5 ANS
- CERAMIQUE
- PORCELAINE VITRIFIEE
- FREIN DE CHUTE
- STOCK EXPRESS



Cuvette Suspendu SMART  
Abattant inclus

Cuvette Courte WC   
L = 48 cm  
POT000SM12 **176 €**



Cuvette Sans Bride   
L = 52 cm  
POT000SM26 **206 €**



- GARANTIE 5 ANS
- CERAMIQUE
- COMPLET AVEC MECANISME
- CHUTE LIBRE
- STOCK EXPRESS

ZAMBAK

WC ZAMBAK   
Complet avec mécanisme  
POT000ZA **154 €**

# Meuble de salle de bain

## K·VIT



**blum**

3 Coloris



Blanc laqué

Chêne gris

Gris laqué

SANITAIRES



Colonne suspendu  
H1400 x L355 x P250mm



Poignées pour meuble PURITY  
Noir Mat  
HAN007 (2pcs) 74 €



Meuble suspendu  
H500 x P450mm



Armoire de toilette  
H650 x P120mm

60cm

80cm

60cm

80cm

Blanc laqué FUR090PU 271 €	Blanc laqué FUR022PU 556 €	Blanc laqué FUR054PU 655 €	Blanc laqué FUR110PU 268 €	Blanc laqué FUR096PU 310 €
Chêne gris PSO1400SU 271 €	Chêne gris PSO600WM 556 €	Chêne gris PSO800WM 655 €	Chêne gris PSO600MIR 268 €	Chêne gris PSO800MIR 310 €
Gris laqué FUR094PU 321 €	Gris laqué FUR026PU 588 €	Gris laqué FUR056PU 690 €	Gris laqué FUR114PU 288 €	Gris laqué FUR098PU 317 €



Meuble KORE avec chassis\*  
H375 x L800 x P355mm

Chêne Sonoma  
KOR800WM-O + KOR-FRAME 799 €

Gris Sombre Mat  
KOR800WM-G + KOR-FRAME 799 €

Blanc Brillant  
KOR800WM-W + KOR-FRAME 799 €



3 Coloris



Blanc Brillant

Chêne Sonoma

Gris Sombre Mat



Ensemble Meuble/Vasque suspendu à poignées chromées  
Composé de 2 caissons de 60cm + 1 plan de vasque céramique 120cm  
H375 x L1200 x P355mm

KOR1200WM-W - Blanc brillant	953 €
KOR1200WM-O - Chêne Sonoma	953 €
KOR1200WM-G - Gris sombre mat	953 €

\* Poignée chromé vendue de serie  
Poignée noire vendue séparément.



Poignées noire pour meuble suspendu

Pour meuble de 600mm  
KOR600HANDLE-B (1pcs) 42 €

Pour meuble de 800mm  
KOR800HANDLE-B (1pcs) 53 €

Autres tailles disponibles sur demande



Mitigeur Lavabo   
Noir Mat avec bonde - Carré TAP007FI **158 €**  
Noir Mat sans bonde - Rond TAP150NR **147 €**



Vidage Lavabo  
Avec trop-plein WAS040 **32 €**  
Sans trop-plein WAS041 **32 €**



Mitigeur baignoire   
Noir Mat avec douche - Carré TAP008FI **296 €**  
Noir Mat avec douche - Rond TAP152NR **264 €**



Vidage baignoire laiton   
Noir Mat sans siphon WAS019 **35 €**



Mitigeur Lavabo  
Or brossé sans bonde TAP140OT **169 €**



Vidage Lavabo  
Avec trop-plein WAS050 **35 €**  
Sans trop-plein WAS051 **35 €**



Mitigeur baignoire  
Or Brossé avec douche TAP142OT **275 €**



Vidage baignoire laiton  
Or brossé sans siphon WAS020 **35 €**



Mitigeur Lavabo réhaussé  
Or brossé sans bonde TAP143OT **211 €**  
Noir Mat sans bonde TAP153NR **211 €**



Mitigeur Lavabo   
LUNA Chromé sans bonde TAP001LU **94 €**



Mitigeur Lavabo   
MYRA chromé sans bonde TAP001MY **94 €**



Vidage Lavabo   
Chromé avec trop-plein WAS006 **24 €**

# Vasque

# K·VIT

# ERCOS

SANITAIRE



Plan de toilette avec vasque (kit 2pcs)

Plan de toilette 460 x 620mm - céramique  
Pré-percée 1T pour robinetterie - Angle droit  
FUR433PU **210 €**

Vasque à poser D420 x H150mm - céramique  
Avec trop-plein intégré  
FUR435PU **149 €**



COMPATIBLE AVEC MEUBLE 60CM  
VOIR PAGE 13



Vasque à poser LOÏS ROUND  
D425 x H145mm - céramique  
Sans trop-plein intégré  
CTB-LOI425 **127 €**



Vasque à poser MUSA O  
D416 x H155mm - céramique Noir Mat  
Sans trop-plein intégré  
BLCER N MUSA001 **208 €**



Vasque à poser MUSA O  
D416 x H155mm - céramique Cappuccino  
Sans trop-plein intégré  
BLCER P MUSA001 **208 €**



Vasque à poser LOÏS SQUARE  
L390 X H145mm - céramique  
Sans trop-plein intégré  
CTB-LOI390 **127 €**



Vasque à poser MUSA C  
D416 x H145mm - céramique Noir Mat  
Sans trop-plein intégré  
BLCER N MUSA0011 **350 €**



Vasque à poser MUSA C  
D416 x H145mm - céramique Cappuccino  
Sans trop-plein intégré  
BLCER P MUSA0011 **350 €**



Vasque à poser ISLAND  
L400 x H120mm - céramique  
Sans trop-plein intégré  
CTB-ISL400 **127 €**



Vasque à poser MUSA R  
360x580xH125mm - céramique Noir Mat  
Sans trop-plein intégré  
BLCER N MUSA0012 **368 €**



Vasque à poser MUSA R  
360x580xH125mm - céramique cappuccino  
Sans trop-plein intégré  
BLCER P MUSA0012 **368 €**

Bonde Click-Clack Céramique  
Sans trop-plein

Blanc Brillant  
BTSCA L VR67  
Noir Mat  
BTSCA N VR67  
Cappuccino Mat  
BTSCA P VR67

**54 €**

**54 €**

**54 €**



15

Siphon Laiton



Chromé  
BTSCA C VR40  
**61 €**

Noir Mat  
BTSCA K VR40  
**81 €**

# ELECTRIQUE





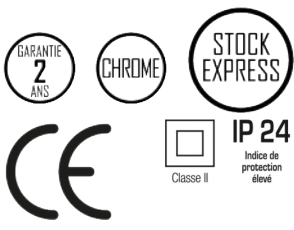

# Les Kits Mixtes

## Sèche-Serviette

ELECTRIQUE

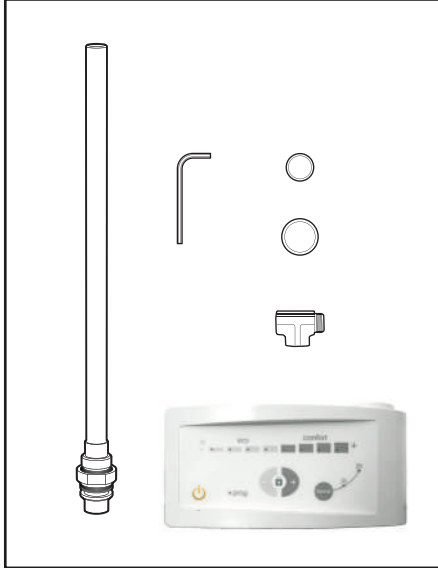

Kit mixte - Blanc

<b>500W</b>	- KIT500B	254€
<b>750W</b>	- KIT750B	256€
<b>1000W</b>	- KIT1000B	277€
<b>1250W</b>	- KIT1250B	279€

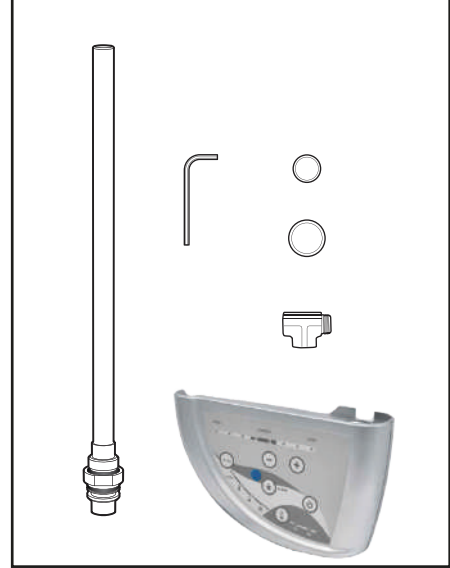

Kit mixte - Gris

<b>500W</b>	- KIT500G	287€
<b>750W</b>	- KIT750G	289€
<b>1000W</b>	- KIT1000G	310€
<b>1250W</b>	- KIT1250G	325€



Kit mixte - Anthracite

<b>300W</b>	- KIT300A	188€
<b>600W</b>	- KIT600A	202€



Kit mixte - Chromé

<b>300W</b>	- KIT300C	188€
<b>600W</b>	- KIT600C	202€



Kit mixte - Noir

<b>300W</b>	- KIT300B	188€
<b>600W</b>	- KIT600B	202€

## CAPRI

Horizontal &amp; Vertical connecté

K·RAD

Nouveau

IP 24  
Indice de protection élevé

2 Coloris

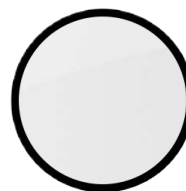

Blanc

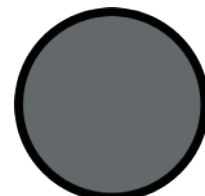

Anthracite



## Fonctionnalités



Détection de fenêtre ouverte



Programmation journalière et hebdomadaire 24/7

Connecté compatible  
App / Google Home / Alexa

## Horizontal

## Version Blanc Brillant

Longueur (mm)	Hauteur (mm)		Réf.	W	€
	500				
544		1000	CAP500-544W		358
725		1500	CAP500-725W		413
907		2000	CAP500-907W		468

## Vertical

Longueur (mm)	Hauteur (mm)		Réf.	W	€
	1600				
362		1000	CAP1600-362W		468
453		1500	CAP1600-453W		550
544		1800	CAP1600-544W		632

## Version Anthracite Mat

Longueur (mm)	Hauteur (mm)		Réf.	W	€
	500				
544		1000	CAP500-544A		369
725		1500	CAP500-725A		429
907		1800	CAP500-907A		490

Longueur (mm)	Hauteur (mm)		Réf.	W	€
	1600				
362		1000	CAP1600-362A		484
453		1500	CAP1600-453A		572
544		1800	CAP1600-544A		660



# E-CLASSICO

## Sèche-Serviette électrique

ELECTRIQUE

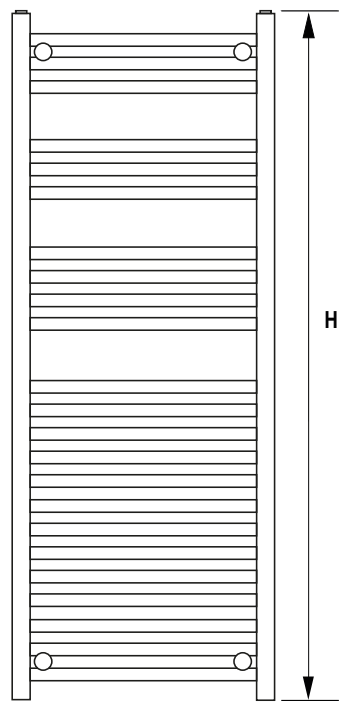
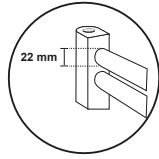

Profil Droit

Profil Droit

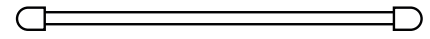
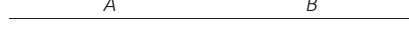
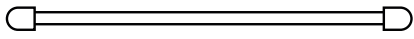

83 / 96

68 / 81

Boîtier de régulation  
fil pilote 6 ordres

Boîtier de régulation  
totalement chromé



### Modèle Blanc

Hauteur (mm)	1000			1200			1600			1800		
	Réf.	W	€	Réf.	W	€	Réf.	W	€	Réf.	W	€
400	E-STR410W	500	401	E-STR412W	500	463	E-STR416W	500	536	---	---	---
500	E-STR510W	500	408	E-STR512W	500	481	E-STR516W	750	544	E-STR518W	750	569
600	E-STR610W	500	433	E-STR612W	500	510	E-STR616W	750	566	E-STR618W	1000	614

### Modèle Chromé

Hauteur (mm)	1000			1200			1600			1800		
	Réf.	W	€	Réf.	W	€	Réf.	W	€	Réf.	W	€
400	E-STR410C	300	580	E-STR412C	300	606	E-STR416C	300	652	---	---	---
500	E-STR510C	300	593	E-STR512C	300	623	E-STR516C	600	672	E-STR518C	600	739
600	---	---	---	---	---	---	---	---	---	E-STR618C	600	784

# CHAUFFAGE





# KOMPACT Horizontal

CHAUFFAGE

## TYPE 11

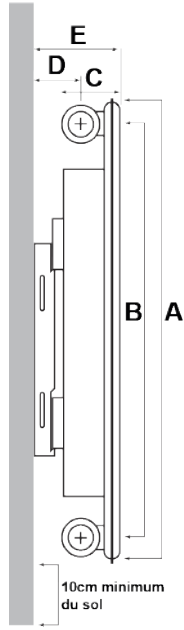
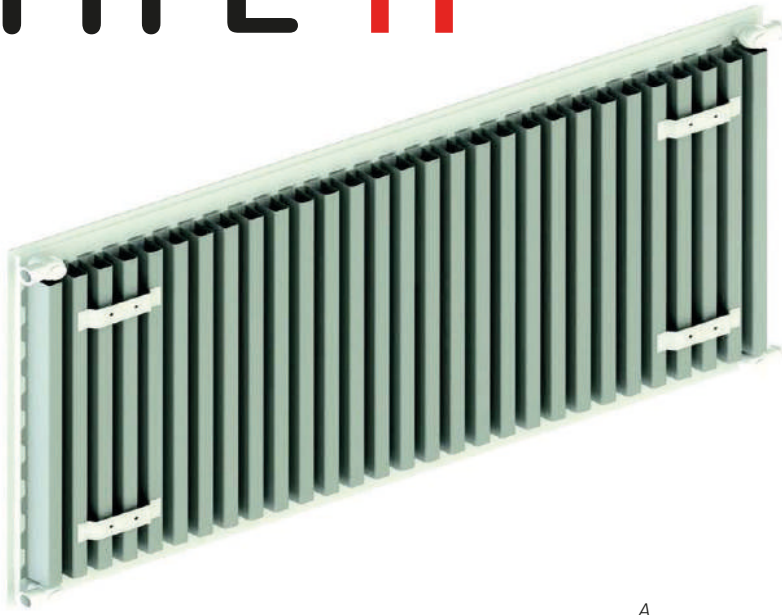

### Raccordements

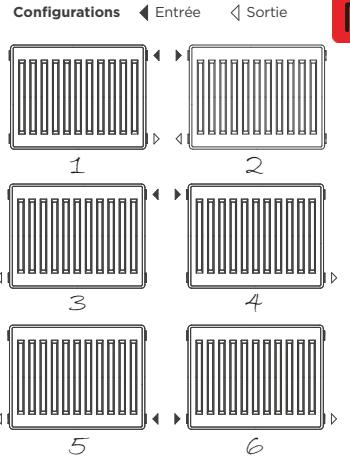

Les raccords 5 et 6 entraînent une perte de puissance du radiateur à hauteur de 20%.

Ici toutes les informations techniques sur les radiateurs KARTELL K-RAD en scannant ce QR CODE !



A	B	C	D	E
300	245			
400	345			
500	445			
600	545	56	40/55	81/96
750	695			
900	845			

Hauteur (mm) 300 400 500 600 750 900

Largeur (mm)	Réf.	W	€	Réf.	W	€	Réf.	W	€	Réf.	W	€	Réf.	W	€	Réf.	W	€
300	---	---	---	---	---	---	S503K	245	180	S603K	285	192	---	---	---	---	---	---
400	S304K	209	83	S404K	270	82	S504K	326	102	S604K	380	104	S704K	430	124	S904K	520	153
500	S305K	262	98	S405K	337	98	S505K	408	127	S605K	475	120	S705K	538	164	S905K	649	191
600	S306K	314	117	S406K	405	116	S506K	490	153	S606K	570	147	S706K	645	196	S906K	779	228
700	S307K	366	134	S407K	472	134	S507K	571	169	S607K	665	167	S707K	752	228	S907K	909	268
800	S308K	418	153	S408K	540	152	S508K	653	204	S608K	760	193	S708K	860	260	S908K	1039	305
900	S309K	471	174	S409K	607	171	S509K	734	231	S609K	855	236	S709K	967	295	S909K	1169	342
1000	S310K	523	190	S410K	675	189	S510K	816	237	S610K	950	268	S710K	1075	329	---	---	---
1100	---	---	---	S411K	742	206	S511K	897	285	S611K	1045	295	S711K	1182	365	---	---	---
1200	S312K	628	228	S412K	810	227	S512K	979	306	S612K	1140	319	S712K	1290	395	---	---	---
1300	---	---	---	---	---	---	S513K	1061	333	S613K	1235	349	---	---	---	---	---	---
1400	S314K	732	248	S414K	945	246	S514K	1142	360	S614K	1330	375	S714K	1505	458	---	---	---
1500	---	---	---	---	---	---	S515K	1224	380	S615K	1425	400	---	---	---	---	---	---
1600	S316K	837	269	S416K	1079	266	S516K	1305	400	S616K	1520	425	S716K	1720	528	---	---	---
1800	---	---	---	S418K	1214	284	S518K	1469	459	S618K	1710	483	S718K	1936	586	---	---	---
2000	S320K	1046	312	S420K	1349	308	S520K	1632	477	S620K	1900	531	---	---	---	---	---	---
2200	---	---	---	S422K	1484	344	S522K	1795	525	S622K	2089	589	---	---	---	---	---	---
2400	---	---	---	---	---	---	S524K	1958	571	S624K	2280	643	---	---	---	---	---	---
2700	---	---	---	S427K	1822	456	S527K	2203	644	S627K	2564	722	---	---	---	---	---	---
3000	---	---	---	S430K	2024	511	S530K	2448	716	S630K	2849	842	---	---	---	---	---	---

Autres tailles disponibles sur demande



# KOMPACT

Horizontal



**K·RAD** **DL** RADIATORS  
ITALIAN PREMIUM HEATING

# TYPE 21



### Raccordements

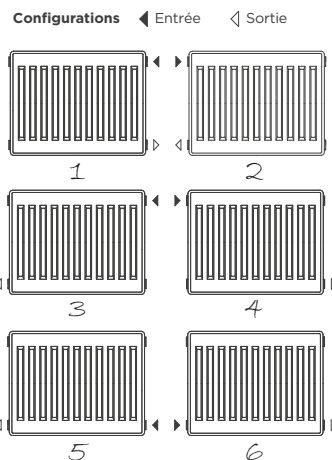

Les raccordements 5 et 6 entraînent une perte de puissance du radiateur à hauteur de 20%.

A	B	C	D	E
300	245			
400	345			
500	445			
600	545	70	65 / 80	95 / 110
750	695			
900	845			

Hauteur (mm)      300                      400                      500                      600                      750                      900

Largeur (mm)	300			400			500			600			750			900		
	Réf.	W	€	Réf.	W	€	Réf.	W	€	Réf.	W	€	Réf.	W	€	Réf.	W	€
300	---	---	---	---	---	---	---	---	---	---	---	---	---	---	---	---	---	---
400	---	---	---	P404K	413	<b>129</b>	P504K	493	<b>126</b>	P604K	566	<b>156</b>	P704K	650	<b>186</b>	P904K	753	<b>210</b>
500	---	---	---	P405K	516	<b>155</b>	P505K	616	<b>174</b>	P605K	708	<b>194</b>	P705K	812	<b>232</b>	P905K	941	<b>263</b>
600	---	---	---	P406K	619	<b>183</b>	P506K	739	<b>210</b>	P606K	849	<b>234</b>	P706K	974	<b>275</b>	P906K	1129	<b>314</b>
700	---	---	---	P407K	722	<b>214</b>	P507K	863	<b>238</b>	P607K	991	<b>271</b>	P707K	1137	<b>310</b>	P907K	1317	<b>370</b>
800	P308K	663	<b>194</b>	P408K	825	<b>243</b>	P508K	986	<b>272</b>	P608K	1132	<b>310</b>	P708K	1299	<b>373</b>	P908K	1506	<b>419</b>
900	P309K	746	<b>219</b>	P409K	928	<b>271</b>	P509K	1109	<b>314</b>	P609K	1274	<b>351</b>	P709K	1462	<b>418</b>	P909K	1694	<b>479</b>
1000	P310K	829	<b>244</b>	P410K	1031	<b>305</b>	P510K	1232	<b>344</b>	P610K	1415	<b>387</b>	P710K	1624	<b>465</b>	---	---	---
1100	P311K	912	<b>275</b>	P411K	1134	<b>337</b>	P511K	1355	<b>378</b>	P611K	1557	<b>431</b>	P711K	1786	<b>509</b>	---	---	---
1200	P312K	995	<b>290</b>	P412K	1238	<b>366</b>	P512K	1479	<b>417</b>	P612K	1698	<b>466</b>	P712K	1949	<b>560</b>	---	---	---
1300	---	---	---	---	---	---	---	---	---	P613K	1840	<b>504</b>	---	---	---	---	---	---
1400	---	---	---	P414K	1444	<b>396</b>	P514K	1725	<b>483</b>	P614K	1981	<b>544</b>	---	---	---	---	---	---
1500	---	---	---	---	---	---	---	---	---	P615K	2123	<b>584</b>	---	---	---	---	---	---
1600	---	---	---	P416K	1650	<b>425</b>	P516K	1972	<b>552</b>	P616K	2264	<b>624</b>	---	---	---	---	---	---
1800	---	---	---	P418K	1856	<b>458</b>	P518K	2218	<b>591</b>	P618K	2547	<b>638</b>	---	---	---	---	---	---
2000	---	---	---	P420K	2063	<b>492</b>	P520K	2464	<b>691</b>	P620K	2830	<b>707</b>	---	---	---	---	---	---
2200	---	---	---	P422K	2269	<b>560</b>	P522K	2711	<b>759</b>	P622K	3114	<b>777</b>	---	---	---	---	---	---
2400	---	---	---	---	---	---	---	---	---	---	---	---	---	---	---	---	---	---
2700	---	---	---	---	---	---	---	---	---	---	---	---	---	---	---	---	---	---
3000	---	---	---	---	---	---	---	---	---	---	---	---	---	---	---	---	---	---

Autres tailles disponibles sur demande





**K·RAD** **DL** RADIATORS  
ITALIAN PREMIUM HEATING

# KOMPACT

## Horizontal

CHAUFFAGE

# TYPE 22

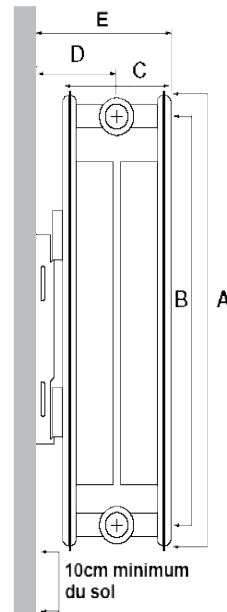

### Raccordements

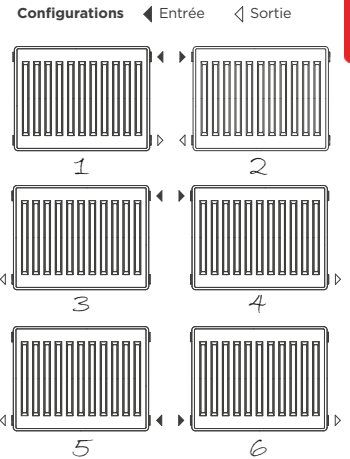

Les raccordements 5 et 6 entraînent une perte de puissance du radiateur à hauteur de 20%.

A	B	C	D	E
300	245			
400	345			
500	445			
600	545	105	82,5 / 97,5	130 / 145
750	695			
900	845			

Hauteur (mm)      300                      400                      500                      600                      750                      900

Largeur (mm)	300			400			500			600			750			900		
	Réf.	W	€	Réf.	W	€	Réf.	W	€	Réf.	W	€	Réf.	W	€	Réf.	W	€
300	---	---	---	---	---	---	D503K	478	<b>249</b>	D603K	551	<b>271</b>	---	---	---	---	---	---
400	D304K	420	<b>116</b>	D404K	533	<b>143</b>	D504K	638	<b>168</b>	D604K	734	<b>174</b>	D704K	830	<b>227</b>	D904K	908	<b>260</b>
500	D305K	524	<b>144</b>	D405K	666	<b>179</b>	D505K	797	<b>212</b>	D605K	917	<b>221</b>	D705K	1038	<b>285</b>	D905K	1225	<b>323</b>
600	D306K	629	<b>177</b>	D406K	800	<b>216</b>	D506K	956	<b>253</b>	D606K	1101	<b>261</b>	D706K	1245	<b>341</b>	D906K	1470	<b>368</b>
700	---	---	---	D407K	933	<b>254</b>	D507K	1116	<b>297</b>	D607K	1284	<b>305</b>	D707K	1453	<b>402</b>	D907K	1715	<b>456</b>
800	D308K	839	<b>227</b>	D408K	1066	<b>289</b>	D508K	1275	<b>340</b>	D608K	1468	<b>344</b>	D708K	1660	<b>458</b>	D908K	1960	<b>525</b>
900	---	---	---	D409K	1199	<b>323</b>	D509K	1435	<b>364</b>	D609K	1651	<b>404</b>	D709K	1868	<b>513</b>	D909K	2205	<b>578</b>
1000	D310K	1049	<b>301</b>	D410K	1333	<b>365</b>	D510K	1594	<b>424</b>	D610K	1835	<b>437</b>	D710K	2075	<b>572</b>	D910K	2450	<b>648</b>
1100	---	---	---	D411K	1466	<b>396</b>	D511K	1754	<b>466</b>	D611K	2018	<b>481</b>	D711K	2283	<b>650</b>	D911K	2695	<b>714</b>
1200	D312K	1259	<b>338</b>	D412K	1599	<b>431</b>	D512K	1913	<b>509</b>	D612K	2202	<b>520</b>	D712K	2490	<b>687</b>	D912K	2940	<b>833</b>
1300	---	---	---	---	---	---	D513K	2072	<b>552</b>	D613K	2385	<b>568</b>	---	---	---	---	---	---
1400	D314K	1469	<b>391</b>	D414K	1866	<b>475</b>	D514K	2232	<b>595</b>	D614K	2569	<b>571</b>	D714K	2905	<b>799</b>	---	---	---
1500	---	---	---	---	---	---	D515K	2391	<b>639</b>	D615K	2752	<b>638</b>	---	---	---	---	---	---
1600	D316K	1679	<b>410</b>	D416K	2132	<b>518</b>	D516K	2551	<b>685</b>	D616K	2935	<b>696</b>	D716K	3320	<b>917</b>	---	---	---
1800	D318K	1888	<b>452</b>	D418K	2399	<b>549</b>	D518K	2869	<b>765</b>	D618K	3302	<b>771</b>	---	---	---	---	---	---
2000	D320K	2098	<b>471</b>	D420K	2665	<b>578</b>	D520K	3188	<b>851</b>	D620K	3669	<b>874</b>	---	---	---	---	---	---
2200	---	---	---	D422K	2932	<b>650</b>	D522K	3507	<b>936</b>	D622K	4036	<b>961</b>	---	---	---	---	---	---
2400	---	---	---	---	---	---	D524K	3826	<b>1022</b>	D624K	4404	<b>1050</b>	---	---	---	---	---	---
2700	---	---	---	---	---	---	---	---	---	D627K	4954	<b>1181</b>	---	---	---	---	---	---
3000	---	---	---	---	---	---	---	---	---	D630K	5504	<b>1313</b>	---	---	---	---	---	---

Autres tailles disponibles sur demande



# KOMPACT

Horizontal



**K·RAD DL RADIATORS**  
ITALIAN PREMIUM HEATING

# TYPE 33

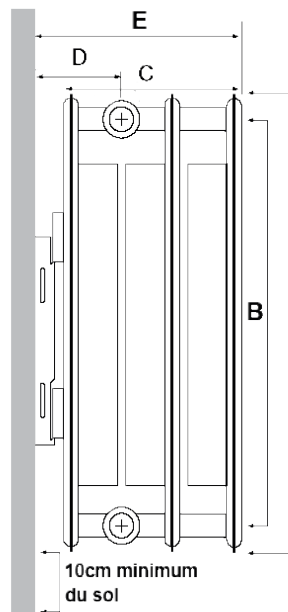

### Raccordements

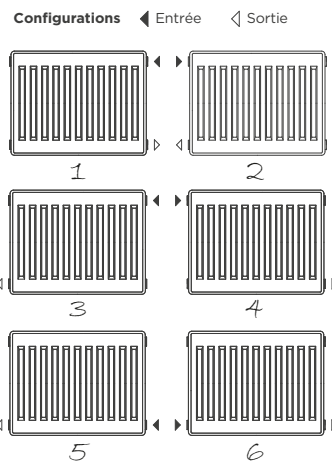

Les raccordements 5 et 6 entraînent une perte de puissance du radiateur à hauteur de 20%.

A	B	C	D	E
300	240			
400	340			
500	440			
600	540	157	75 / 83	182 / 190
700	640			
900	840			

Hauteur (mm)      300                      400                      500                      600                      700                      900

Largeur (mm)	Réf.	W	€	Réf.	W	€	Réf.	W	€	Réf.	W	€	Réf.	W	€	Réf.	W	€
400	---	---	---	---	---	---	T504K	853	240	T604K	1006	271	T704K	1107	324	T904K	1366	368
500	---	---	---	---	---	---	T505K	1066	302	T605K	1257	347	T705K	1384	406	T905K	1709	462
600	T306K	859	267	T406K	1080	305	T506K	1279	359	T606K	1508	410	T706K	1661	489	T906K	2050	552
700	---	---	---	---	---	---	T507K	1492	420	T607K	1760	479	T707K	1938	568	T907K	2392	649
800	T308K	1145	362	T408K	1440	422	T508K	1706	483	T608K	2011	543	T708K	2214	649	T908K	2734	740
900	T309K	1288	404	---	---	---	T509K	1919	541	T609K	2263	608	T709K	2491	731	T909K	3075	835
1000	T310K	1431	450	T410K	1816	509	T510K	2132	605	T610K	2514	679	T710K	2768	812	T910K	3417	925
1100	T311K	1574	495	T411K	1998	560	T511K	2345	660	T611K	2765	748	---	---	---	---	---	---
1200	T312K	1742	537	T412K	2179	604	T512K	2558	733	T612K	3017	813	T712K	3322	974	T912K	4061	1107
1400	T314K	2033	585	T414K	2542	662	T514K	2985	846	T614K	3520	951	T714K	3875	1138	T914K	4738	1308
1600	T316K	2323	629	T416K	2880	713	T516K	3411	962	T616K	4022	1056	T716K	4429	1328	---	---	---
1800	T318K	2614	675	T418K	3240	764	T518K	3838	1086	T618K	4525	1225	T718K	4982	1462	---	---	---
2000	T320K	2904	718	T420K	3600	812	---	---	---	T620K	5028	1364	T720K	5536	1625	---	---	---
2300	T323K	3340	807	T423K	4140	918	---	---	---	---	---	---	---	---	---	---	---	---
2600	T326K	3775	903	---	---	---	---	---	---	---	---	---	---	---	---	---	---	---
3000	T330K	4356	1067	---	---	---	---	---	---	T630K	7362	2045	---	---	---	---	---	---



Les modèles inscrits en **ROUGE** sont disponibles sur stock dépôt ou stock usine.  
~ disponible sous 3 semaines en moyenne.

Les autres référence nécessitent d'être fabriqués -  
Délai variable suivant fabricant et conjoncture - Nous consulter

**Autres tailles disponibles sur demande**





# ACCESSOIRE

## KOMPACT Horizontal

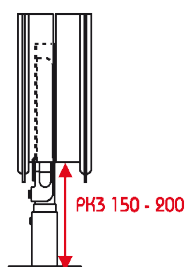
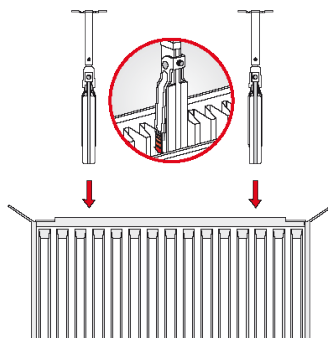

T11 / T21 / T22 / T33

PK3

104 €

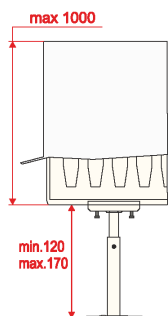

T22 / T33

PX

113 €

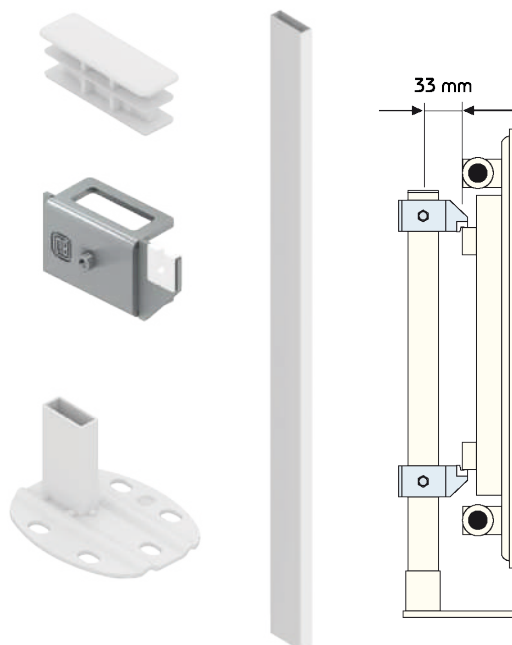

T11 / T21 / T22

102470

87 €

# KOMPACT

Vertical



# TYPE 10-21-22

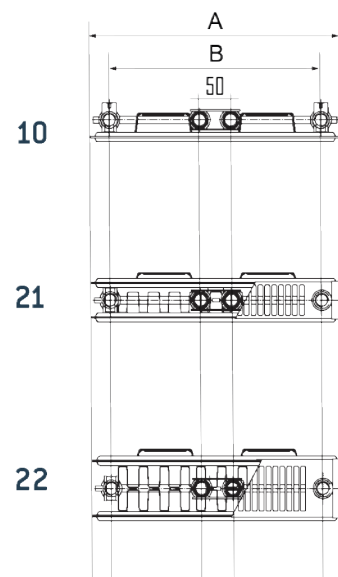
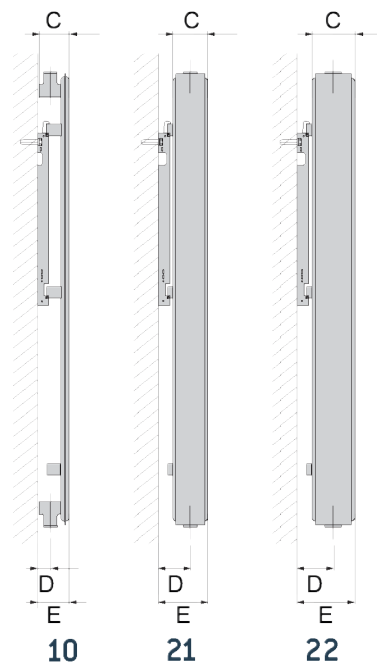

A	B		C	D	E
300	240	TYPE 10	62	35	70
400	340				
500	440	TYPE 21	70	58 / 66	93 / 101
600	540				
700	640	TYPE 22	102	74 / 82	125 / 133
900	840				

## TYPE 10

Hauteur (mm)                      1600    1800    2000

Largeur (mm)	1600			1800			2000		
	Réf.	W	€	Réf.	W	€	Réf.	W	€
300	---	---	---	BV101800300	527	<b>397</b>	BV102000300	587	<b>423</b>
400	BV101600400	554	<b>392</b>	BV101800400	703	<b>423</b>	BV102000400	782	<b>451</b>
500	BV101600500	692	<b>414</b>	BV101800500	879	<b>448</b>	BV102000500	978	<b>480</b>
600	BV101600600	831	<b>437</b>	BV101800600	1055	<b>473</b>	BV102000600	1174	<b>508</b>
700	---	---	---	BV101800700	1231	<b>499</b>	BV102000700	1368	<b>537</b>
900	---	---	---	---	---	---	BV102000900	1760	<b>594</b>

## TYPE 21

Hauteur (mm)                      1600    1800    2000

Largeur (mm)	1600			1800			2000		
	Réf.	W	€	Réf.	W	€	Réf.	W	€
300	---	---	---	BV211800300	961	<b>707</b>	BV212000300	1038	<b>755</b>
400	BV211600400	1176	<b>721</b>	BV211800400	1281	<b>777</b>	BV212000400	1384	<b>832</b>
500	BV211600500	1470	<b>738</b>	BV211800500	1601	<b>797</b>	BV212000500	1730	<b>856</b>
600	BV211600600	1764	<b>822</b>	BV211800600	1921	<b>888</b>	BV212000600	2076	<b>955</b>
700	---	---	---	BV211800700	2241	<b>980</b>	BV212000700	2422	<b>1055</b>
900	---	---	---	---	---	---	---	---	---

**Autres tailles disponibles sur demande**



# KOMPACT Vertical

CHAUFFAGE



## TYPE 22

Largeur (mm)	1600			1800			2000		
	Réf.	W	€	Réf.	W	€	Réf.	W	€
300	---	---	---	---	---	---	---	---	---
400	BV221600400	1426	<b>829</b>	BV221800400	1552	<b>893</b>	BV222000400	1687	<b>957</b>
500	BV221600500	1782	<b>849</b>	BV221800500	1940	<b>917</b>	BV222000500	2109	<b>984</b>
600	BV221600600	2139	<b>945</b>	BV221800600	2328	<b>1022</b>	BV222000600	2531	<b>1099</b>
700	---	---	---	---	---	---	---	---	---
900	---	---	---	---	---	---	---	---	---

### Autres tailles disponibles sur demande

### RACCORDEMENTS POSSIBLES

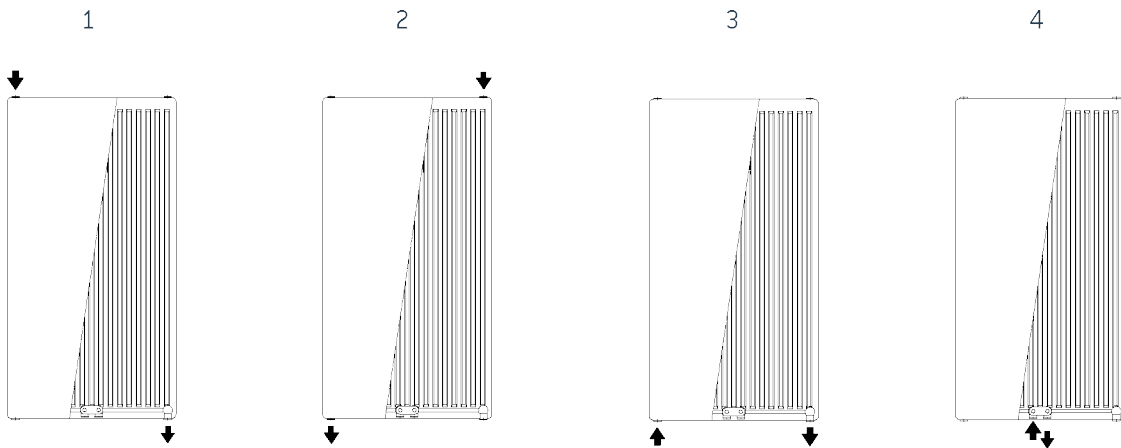

### ACCESSOIRES



Pied de support - Kit 2 pcs  
Pour Type 22 UNIQUEMENT

PX **113 €**

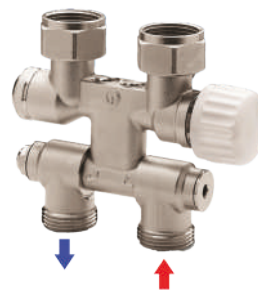

Vanne H thermostatisable orientable drainable avec bypass pour système monotube ou bitube - 3/4" MF

927 **121,00 €**



Adaptateur radiateur pour manchon 1/2" 0915SN **5,00 €**



Adaptateur Multicouche Ø16mm 3015SCRN\_3/4"x16 **12,80 €**



Adaptateur P.E.R. Ø16mm 3015N\_3/4"x16 **10,30 €**



Adaptateur Cuivre Double étanchéité Ø14mm 3625N\_3/4"x14 **10,10 €**  
Ø16mm 3625N\_3/4"x16 **10,10 €**

# K-FLAT

Radiateur à face lisse

## KARTELL<sup>UK</sup>



vertical

### TYPE 10 K·RAD

Hauteur (mm) 1800

Largeur (mm)	Réf.	W	€
300	SV318F	388	<b>518</b>
400	SV418F	519	<b>602</b>
500	SV518F	648	<b>652</b>
600	SV618F	782	<b>727</b>

### TYPE 20 K·RAD

Hauteur (mm) 1800 2000

Largeur (mm)	Réf.	W	€	Réf.	W	€
300	DV318F	644	<b>731</b>	---	---	---
400	DV418F	861	<b>741</b>	DV420F	965	<b>795</b>
500	DV518F	1068	<b>800</b>	---	---	---
600	DV618F	1282	<b>902</b>	---	---	---

Type 10/20

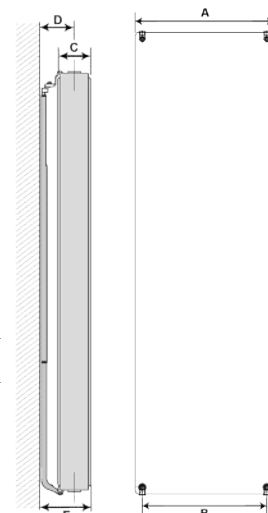

Horizontal

A1	B1	C1	D1	E1	
400	345	TYPE 11	56	40/55	75/90
500	445	TYPE 22	105	82/97	135/150
600	545				

Type 11

Type 22

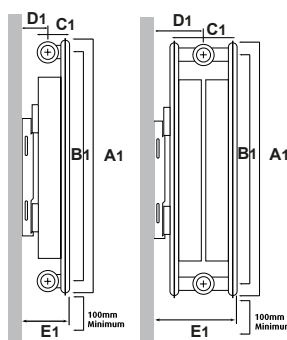

vertical

A	B	C	D	E	
300	245	TYPE 10	52,5	42	78
400	345				
500	445	TYPE 20	72,5	59	98
600	545				

K·RAD

TYPE 11

Horizontal  
Hauteur (mm)

400

500

600

Largeur (mm)	Réf.	W	€	Réf.	W	€	Réf.	W	€
400	---	---	---	KS504F	297	<b>273</b>	KS604F	345	<b>289</b>
600	KS406F	245	<b>296</b>	KS506F	445	<b>320</b>	KS606F	517	<b>348</b>
800	KS408F	491	<b>340</b>	KS508F	593	<b>385</b>	KS608F	691	<b>425</b>
1000	KS410F	613	<b>396</b>	KS510F	741	<b>452</b>	KS610F	863	<b>498</b>
1200	KS412F	736	<b>459</b>	KS512F	889	<b>528</b>	KS612F	1036	<b>561</b>
1400	KS414F	858	<b>508</b>	KS514F	1039	<b>586</b>	KS614F	1209	<b>604</b>
1600	KS416F	981	<b>566</b>	KS516F	1187	<b>642</b>	KS616F	1382	<b>681</b>
1800	---	---	---	---	---	---	KS618F	1555	<b>783</b>
2000	---	---	---	---	---	---	KS620F	1728	<b>848</b>

K·RAD

TYPE 22

Horizontal  
Hauteur (mm)

400

500

600

Largeur (mm)	Réf.	W	€	Réf.	W	€	Réf.	W	€
400	---	---	---	KD504F	579	<b>344</b>	KD604F	667	<b>380</b>
600	KD406F	484	<b>371</b>	KD506F	869	<b>426</b>	KD606F	1000	<b>476</b>
800	KD408F	968	<b>453</b>	KD508F	1159	<b>525</b>	KD608F	1334	<b>596</b>
1000	KD410F	1211	<b>537</b>	KD510F	1449	<b>626</b>	KD610F	1667	<b>715</b>
1200	KD412F	1453	<b>630</b>	KD512F	1738	<b>738</b>	KD612F	2001	<b>845</b>
1400	KD414F	1695	<b>708</b>	KD514F	2030	<b>835</b>	KD614F	2336	<b>958</b>
1600	KD416F	1939	<b>795</b>	KD516F	2320	<b>928</b>	KD616F	2670	<b>1069</b>
1800	---	---	---	---	---	---	KD618F	3004	<b>1178</b>
2000	---	---	---	---	---	---	KD620F	3337	<b>1288</b>



# LINEAR

Radiateur à face lisse



CHAUFFAGE

Vertical

Horizontal

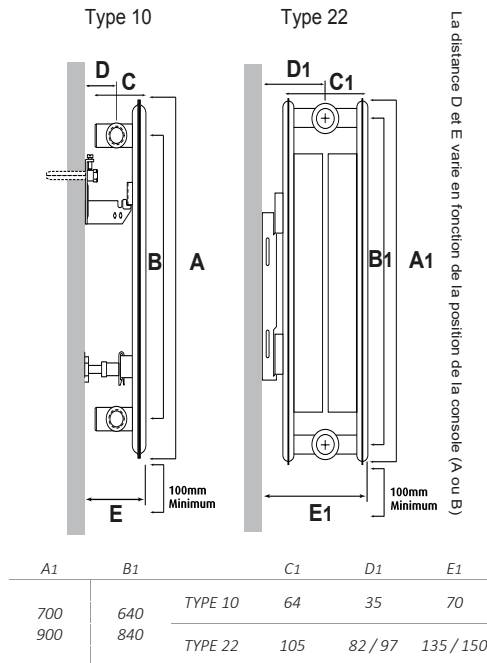
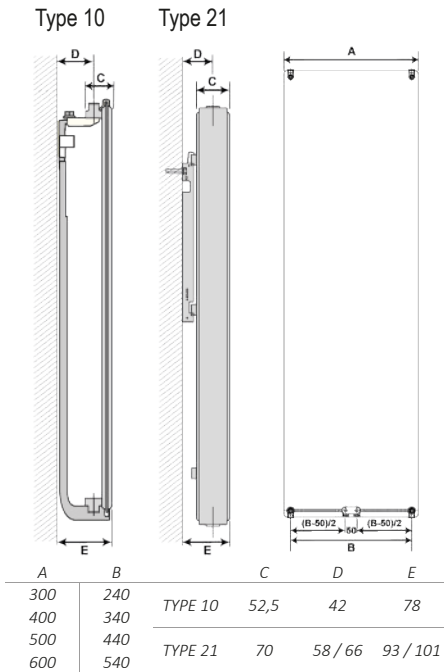

La distance D et E varie en fonction de la position de la console (A ou B)



## TYPE 10 Horizontal



Hauteur (mm)

700

900

Largeur (mm)	700			900		
	Réf.	W	€	Réf.	W	€
400	---	---	---	KS904F	307	<b>381</b>
500	---	---	---	KS905F	684	<b>435</b>
600	KS706F	343	<b>454</b>	KS906F	460	<b>489</b>
800	KS708F	458	<b>552</b>	---	---	---
1000	KS710F	572	<b>651</b>	---	---	---

## TYPE 22 Horizontal



Hauteur (mm)

700

900

Largeur (mm)	700			900		
	Réf.	W	€	Réf.	W	€
400	---	---	---	KD904F	909	<b>468</b>
500	---	---	---	KD905F	1136	<b>628</b>
600	KD706F	1116	<b>552</b>	KD906F	1363	<b>744</b>
800	KD708F	1488	<b>691</b>	---	---	---
1000	KD710F	1860	<b>829</b>	---	---	---

## TYPE 10 - vertical



Hauteur (mm)

1800

2000

Largeur (mm)	1800			2000		
	Réf.	W	€	Réf.	W	€
300	SV318F-D	388	<b>841</b>	SV320F-D	505	<b>909</b>
400	SV418F-D	519	<b>905</b>	SV420F-D	673	<b>976</b>
500	SV518F-D	648	<b>970</b>	SV520F-D	841	<b>1043</b>
600	SV618F-D	782	<b>1034</b>	SV620F-D	1009	<b>1110</b>

## TYPE 21 - vertical



Hauteur (mm)

1800

2000

Largeur (mm)	1800			2000		
	Réf.	W	€	Réf.	W	€
300	PV318F	883	<b>1147</b>	PV320F	946	<b>1197</b>
400	PV418F	1177	<b>1218</b>	PV420F	1261	<b>1278</b>
500	PV518F	1471	<b>1277</b>	PV520F	1577	<b>1345</b>
600	PV618F	1766	<b>1394</b>	PV620F	1892	<b>1474</b>

Autres tailles disponibles sur demande

# RONDO

## Horizontal & Vertical



# KARTELL<sup>UK</sup>

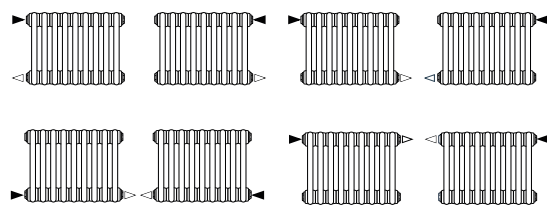
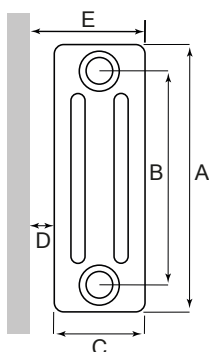
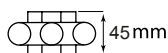
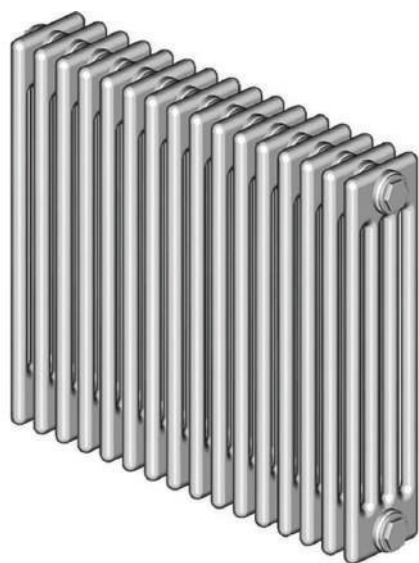

A	B	C	D	E
300	235	2 Colonnes	66	101
400	355	3 Colonnes	107	142
600	538	4 Colonnes	148	183
750	685	6 Colonnes	230	265
1500	1435			
1800	1735			

## HORIZONTAL

Nb d'élément	Hauteur (mm) 300			400			600			750			
	Longueur (mm)	Réf.	W	€	Réf.	W	€	Réf.	W	€	Réf.	W	€
<b>2 Colonnes</b>													
14	650	---	---	---	---	---	LCL206014	627	<b>337</b>	---	---	---	---
18	830	---	---	---	---	---	LCL206018	806	<b>424</b>	---	---	---	---
22	1010	---	---	---	---	---	LCL206022	986	<b>513</b>	---	---	---	---
26	1190	---	---	---	---	---	LCL206026	1165	<b>598</b>	---	---	---	---
<b>3 Colonnes</b>													
14	650	---	---	---	---	---	LCL306014	851	<b>366</b>	---	---	---	---
18	830	---	---	---	---	---	LCL306018	1054	<b>464</b>	---	---	---	---
22	1010	---	---	---	---	---	LCL306022	1338	<b>556</b>	---	---	---	---
26	1190	---	---	---	---	---	LCL306026	1581	<b>654</b>	---	---	---	---
<b>4 Colonnes</b>													
14	650	---	---	---	LCL404014	777	<b>513</b>	LCL406014	1135	<b>414</b>	LCL407514	1400	<b>471</b>
18	830	---	---	---	LCL404018	999	<b>654</b>	LCL406018	1460	<b>527</b>	LCL407518	1800	<b>590</b>
22	1010	---	---	---	LCL404022	1221	<b>795</b>	LCL406022	1784	<b>633</b>	LCL407522	2200	<b>717</b>
26	1190	---	---	---	LCL404026	1443	<b>935</b>	LCL406026	2109	<b>747</b>	LCL407526	2600	<b>844</b>
<b>6 Colonnes</b>													
22	1010	LCL603022	1371	<b>996</b>	---	---	---	---	---	---	---	---	---
26	1190	LCL603026	1620	<b>1152</b>	---	---	---	---	---	---	---	---	---
30	1370	LCL603030	1869	<b>1326</b>	---	---	---	---	---	---	---	---	---

## VERTICAL

Nb d'élément	Hauteur (mm) 1500			1800			
	Longueur (mm)	Réf.	W	€	Réf.	W	€
<b>2 Colonnes</b>							
7	335	LCL215007	746	<b>387</b>	LCL218007	895	<b>396</b>
9	425	LCL215009	959	<b>492</b>	LCL218009	1151	<b>503</b>
11	515	LCL215011	1172	<b>590</b>	LCL218011	1407	<b>605</b>
<b>3 Colonnes</b>							
7	335	---	---	---	LCL318007	962	<b>464</b>
9	425	---	---	---	LCL318009	1237	<b>597</b>
11	515	---	---	---	LCL318011	1512	<b>717</b>

**Autres tailles disponibles sur demande**



**DL RADIATORS**  
ITALIAN PREMIUM HEATING

# RONDO

## Sur-mesure

**CHAUFFAGE**

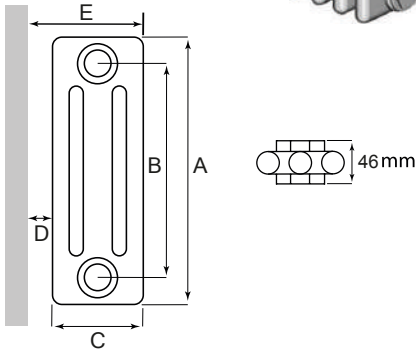
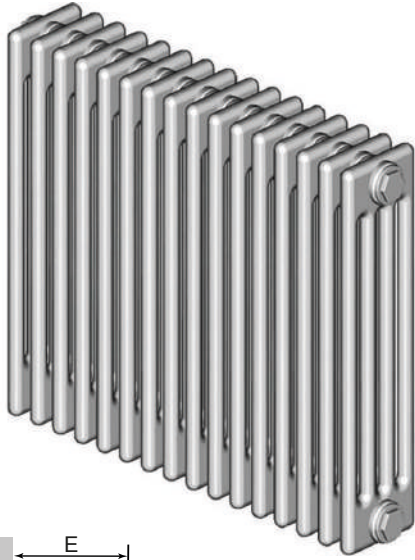

### RACCORDEMENTS

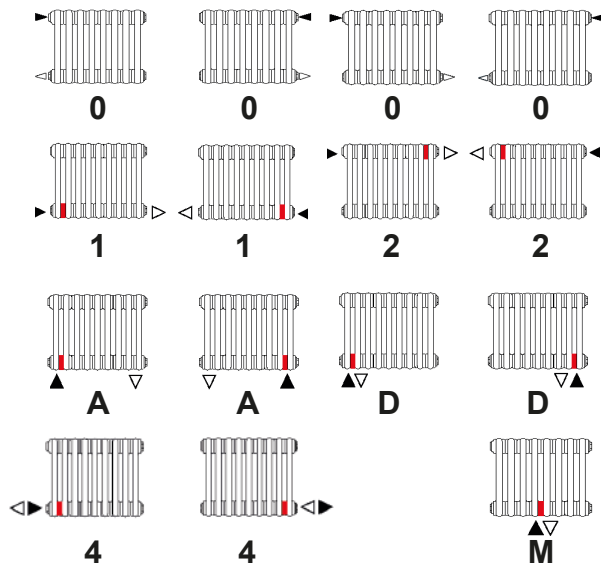

0 - sans supplément

1 - 30 €

2 - 45 €

A - 110 €

D - 110 €

4 - 45 €

M - 190 €

A	B	C	D	E
300	230	66	35	101
400	330	107	35	142
500	430	148	35	183
600	530	189	35	224
750	680	230	35	265
800	730			
900	830			
1000	930			
1200	1130			
1800	1730			
2000	1930			
2200	2130			

$L_{total} \text{ (en mm)} = (\text{nb d'élément} \times 46) + 26\text{mm}$

Réf = remplacer X par nb d'élément (ex. 6/300-10)

Hauteur (mm)	2 Colonnes			3 Colonnes			4 Colonnes			5 Colonnes			6 Colonnes		
	Réf.	W	€	Réf.	W	€	Réf.	W	€	Réf.	W	€	Réf.	W	€
300	2/300-X	24,3	38	3/300-X	33,1	40	4/300-X	42,3	49	5/300-X	51,9	54	6/300-X	62,3	57
400	2/400-X	31,1	26	3/400-X	42,3	28	4/400-X	55,5	36	5/400-X	67,2	41	6/400-X	81,0	46
500	2/500-X	38,0	27	3/500-X	51,6	29	4/500-X	68,3	29	5/500-X	82,2	43	6/500-X	99,4	48
600	2/600-X	44,8	28	3/600-X	60,8	31	4/600-X	81,1	39	5/600-X	97,0	45	6/600-X	117,5	50
750	2/750-X	55,0	29	3/750-X	74,5	33	4/750-X	100,0	41	5/750-X	119,0	48	6/750-X	144,4	53
800	2/800-X	58,4	37	3/800-X	79,1	43	4/800-X	106,3	54	5/800-X	126,3	63	6/800-X	153,3	69
900	2/900-X	65,1	31	3/900-X	88,2	35	4/900-X	118,9	44	5/900-X	140,8	51	6/900-X	171,0	57
1000	2/1000-X	72,1	32	3/1000-X	97,4	36	4/1000-X	131,5	46	5/1000-X	155,4	53	6/1000-X	188,6	59
1200	2/1200-X	85,6	34	3/1200-X	116,0	39	4/1200-X	156,6	50	5/1200-X	184,5	58	6/1200-X	223,8	65
1800	2/1800-X	127,7	52	3/1800-X	173,6	62	4/1800-X	232,3	82	5/1800-X	272,9	95	6/1800-X	328,9	107
2000	2/2000-X	142,3	56	3/2000-X	193,7	67	4/2000-X	257,8	87	5/2000-X	302,9	102	6/2000-X	364,0	116
2200	2/2200-X	157,2	59	3/2200-X	214,2	71	4/2200-X	283,5	95	5/2200-X	333,3	110	6/2200-X	399,2	125

Accessoires à commander séparément

Autres tailles disponibles sur demande

### ACCESSOIRES

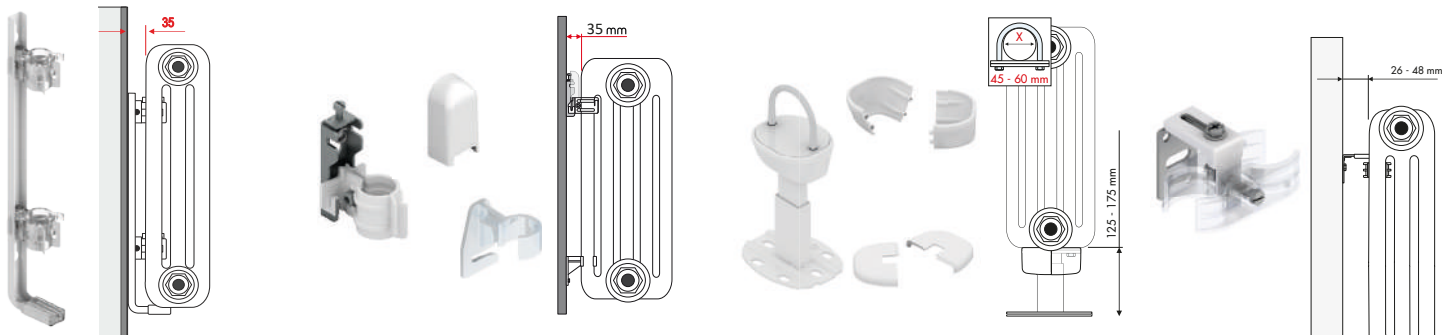

Kit Fixation Murale - 1pcs

- GTX - H300 **23 €**
- GTX - H400 **23 €**
- GTX - H500-700 **24 €**
- GTX - H750-1000 **26 €**

Kit Fixation Murale  
2 pcs

GBT **35 €**

Kit Fixation sur pieds  
2 pcs

PGT60 **121 €**

Kit Anti-basculement  
utilisé avec PGT 60 - 2 pcs

BG3 **25 €**

## HERITAGE

Radiateur en Fonte

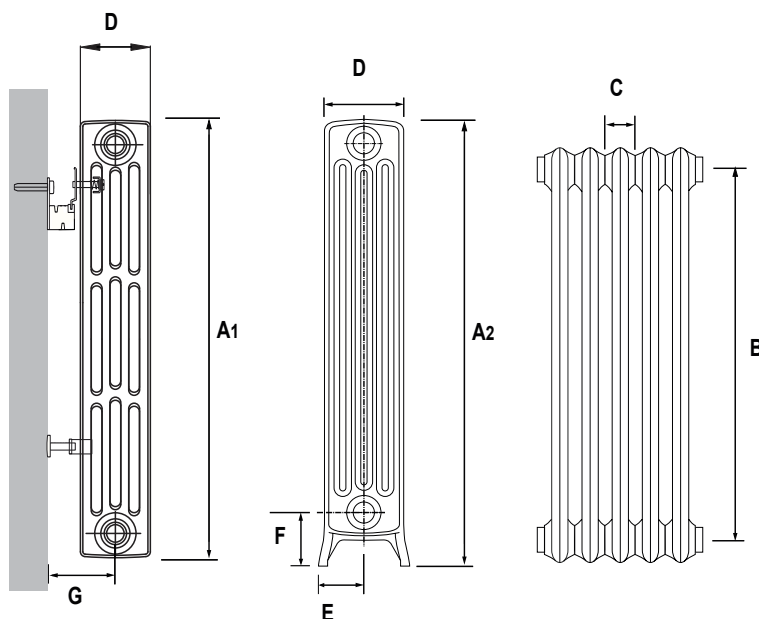

## DIMENSIONS (en mm)

Référence	A1	A2	B	C	D	E	F	G
4/28L	300	360	200					
4/45L	415	475	315					
4/65L	600	660	500					
4/75L	700	760	600	60	144	94,5	113	97 / 107 / 117
4/95L	900	960	800					
6/48L	425	485	350	60	221	133	113	135,5 / 145,5 / 155,5
6/65L	600	660	500					

Longueur totale en mm = ( Nb d'élément x 60 ) + 20

Référence	Nombre de colonne	Poids d'un élément	Poids d'un élément-Pied	W	€
4/28L	4	2,60	3,20	46	58
4/45L	4	3,70	4,30	62	60
4/65L	4	5,37	6,41	87	65
4/75L	4	6,27	6,97	100	74
4/95L	4	7,96	8,54	124	81
6/48L	6	5,90	6,72	94	74
6/65L	6	8,09	9,10	126	84



Les radiateurs en fonte sont fournis en peinture d'apprêt Anthracite RAL7022.  
Nous recommandons la réalisation d'une peinture de finition avant installation.  
Il est impératif de vérifier de serrage de chaque nippes avant la mise en eau.





# RENAISSANCE

Radiateur en Fonte

CHAUFFAGE

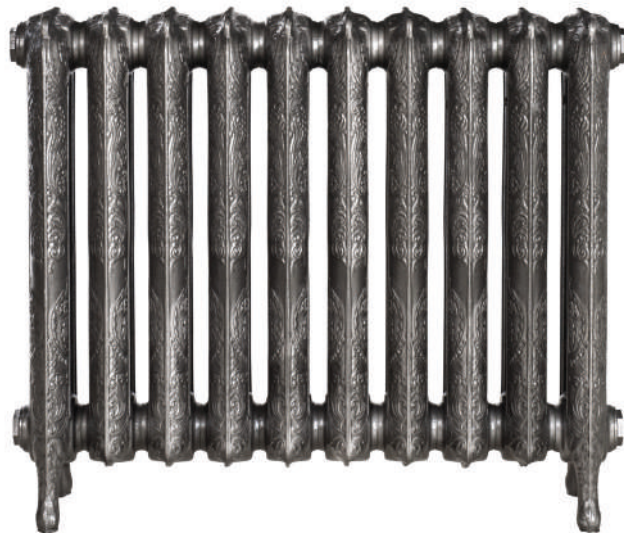
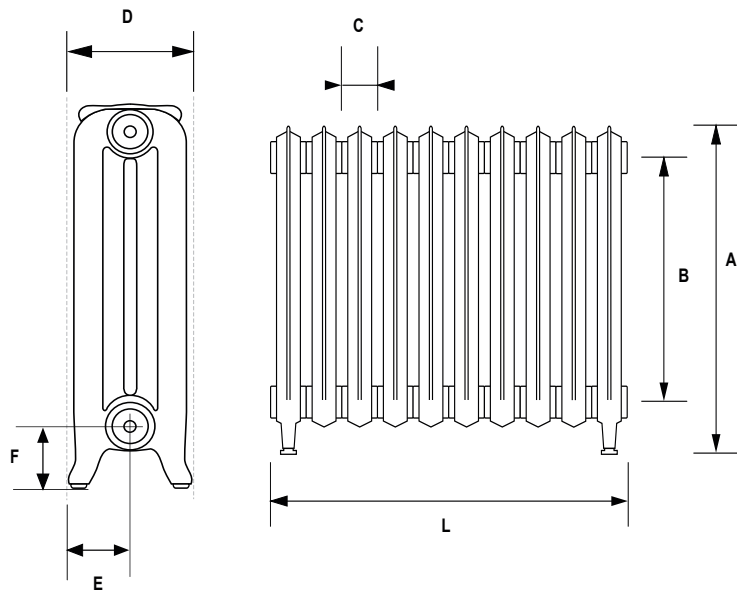

## DIMENSIONS (en mm)

Référence	A	B	C	D	E	F
350180	510	350				
500180	660	500	76	180	127	113
600180	760	600				
800180	954	795				

Longueur totale **L** en mm = (Nb d'élément x 76) + 20

Référence	Nombre de colonne	Poids d'un élément	W	€
350180	2	8,04	74	92
500180	2	10,50	106	95
600180	2	11,96	120	116
800180	2	14,88	148	193



Les radiateurs en fonte sont fournis en peinture d'apprêt Anthracite RAL7022. Nous recommandons la réalisation d'une peinture de finition avant installation. Il est impératif de vérifier de serrage de chaque nipple avant la mise en eau.

# FLOREAL

Radiateur en Fonte

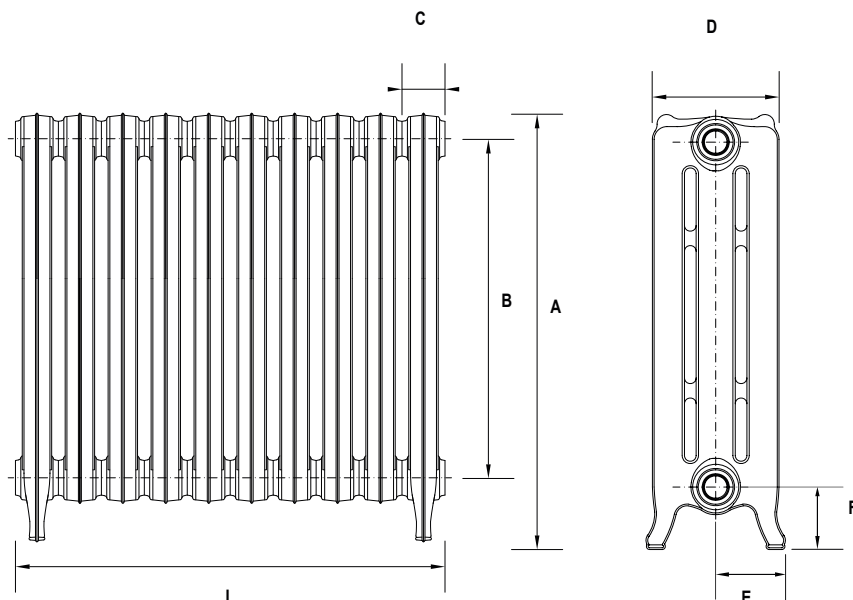

## DIMENSIONS (en mm)

Référence	A	B	C	D	E	F
600225P	768	600	76	225	162	113
800225P	950	795	76	225	162	113

Longueur totale **L** en mm = (Nb d'élément x 76) + 20

Référence	Nombre de colonne	Poids d'un élément	W	€
600225P	3	12,66	139	184
800225P	3	15,31	180	245



Les radiateurs en fonte sont fournis en peinture d'apprêt Anthracite RAL7022.  
Nous recommandons la réalisation d'une peinture de finition avant installation.  
Il est impératif de vérifier de serrage de chaque nipple avant la mise en eau.



Kit Fixation Murale  
1 kit par tranche de 10 elts

P13 **35 €**



Console Anti-basculement  
Pour radiateur sur pied

CR **20 €**



Kit Bouchonnage

KB3342 1"1/4 **23 €**

KB2634 1" **23 €**



Kit d'assemblage

KA3342 1"1/4 **7 €**

KA2634 1" **7 €**



Pied de soutien décoratif  
Modèle Héritage Uniquement

PL **38 €**



Kit Robinet Manette  
Eq. 1/2" MF - Laiton veilli

RMF **195 €**



Kit Robinetterie Volant  
Eq. 1/2" MF - Laiton veilli

RVF **185 €**

# MAGNO

Horizontal & Vertical

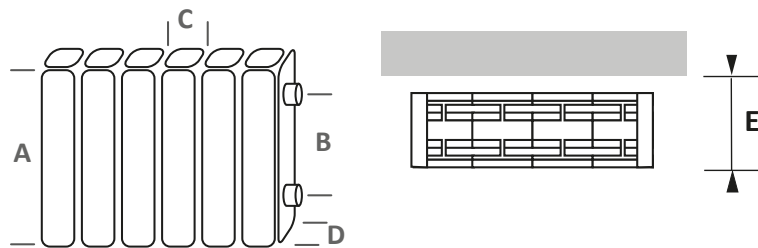

A	B	C	D	E
350	260			
430	350			
580	500	80	95	120
680	600			
780	700			
1870	1830	80	100	115

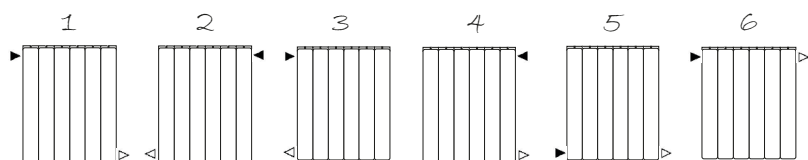

5 & 6 incompatible avec modèle Horizontal -  
Nécessite l'ajout d'un déflecteur (sur demande)

## HORIZONTAL



Nb d'éléments	Hauteur (mm)	350			430			580			680			780		
		Réf.	W	€	Réf.	W	€	Réf.	W	€	Réf.	W	€	Réf.	W	€
		<b>A l'élément</b>														
1	80	Magno350	75	27	Magno430	92	29	Magno580	126	32	Magno680	144	36	Magno780	160	40
		<b>Assemblés</b>														
5	400	Magno350-5	375	135	Magno430-5	460	145	Magno580-5	630	160	Magno680-5	720	180	Magno780-5	800	200
10	800	Magno350-10	750	270	Magno430-10	920	290	Magno580-10	1260	320	Magno680-10	1440	360	Magno780-10	1600	400
15	1200	Magno350-15	1125	405	Magno430-15	1380	435	Magno580-15	1890	480	Magno680-15	2160	540	Magno780-15	2400	600
20	1600	Magno350-20	1500	540	Magno430-20	1840	580	Magno580-20	2520	640	Magno680-20	2880	720	Magno780-20	3200	800

## ACCESSOIRES



Kit Bouchon et Fixation  
KITRADIALU 32 €



Kit Fixation sur pieds (2 pcs)  
PAL 92 €



\*\*\*  
EURO NORM  
**ENI 442**

# PIEVE & ALBA

Sèche-Serviette

CHAUFFAGE

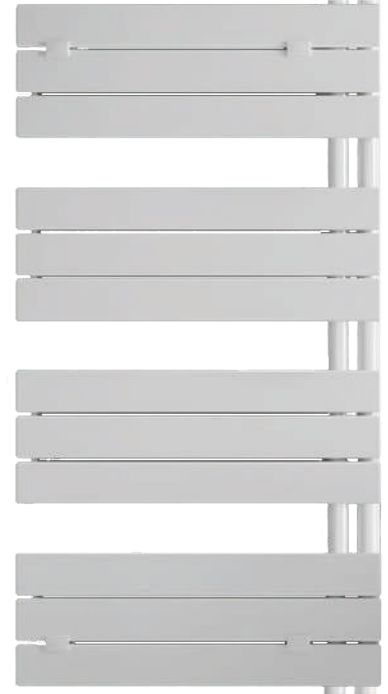
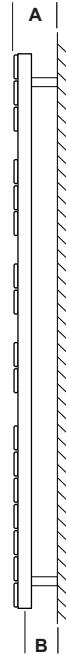
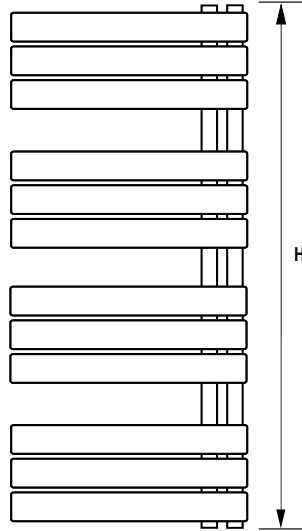

Profil Courbé - PIEVE

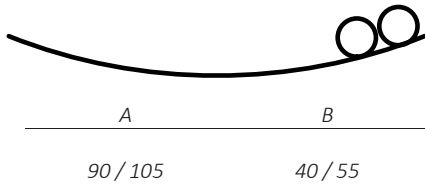

Profil Droit - ALBA

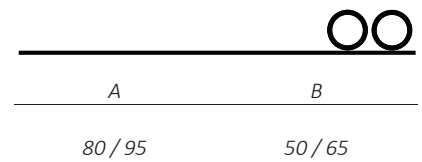

Kit Robinet Blanc  
Equerre  
**KRB-15 130€**

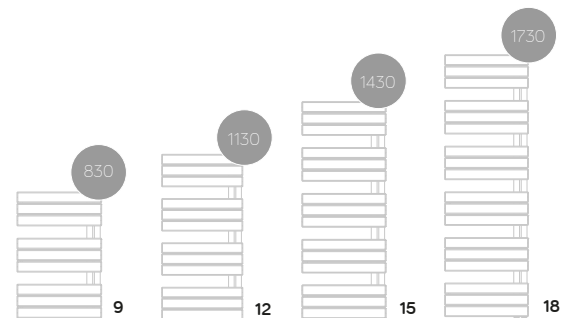
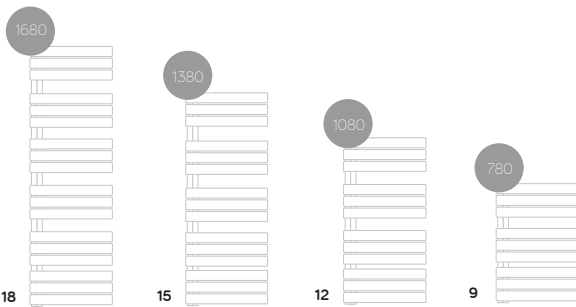

## Modèle droit - ALBA

	Hauteur (mm) 830			Hauteur (mm) 1130			Hauteur (mm) 1430			Hauteur (mm) 1730		
	Réf.	W	€	Réf.	W	€	Réf.	W	€	Réf.	W	€
500	ALB508W	374	465	ALB512W	483	527	ALB515W	602	585	ALB517W	731	646

## Modèle courbé - PIEVE

	Hauteur (mm) 780			Hauteur (mm) 1080			Hauteur (mm) 1380			Hauteur (mm) 1680		
	Réf.	W	€	Réf.	W	€	Réf.	W	€	Réf.	W	€
500	PIE578W	365	449	PIE510W	500	503	PIE513W	624	554	PIE516W	738	611

# CLASSICO 22

Sèche-Serviette

**KARTELL**<sup>UK</sup>



\*\*\* Euronorm  
**ENI 442**

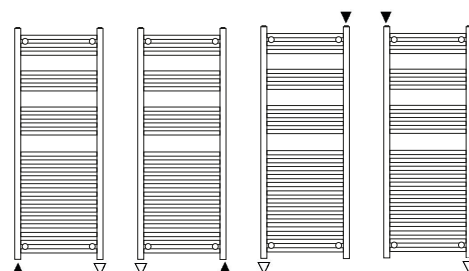
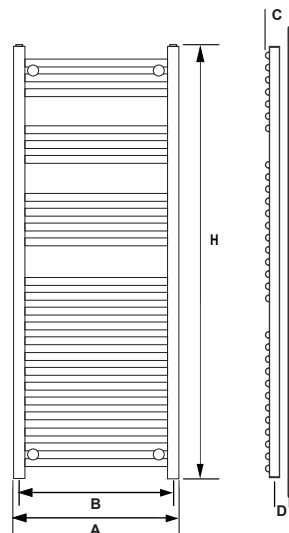
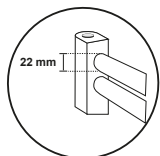

Profil Droit

Profil Courbé



A	B	C	D
300	255		
400	355		
500	455	83 / 96	68 / 81
600	555		

## Modèle Blanc - Droit

Hauteur (mm)	800			1000			1200			1600			1800		
	Réf.	W	€	Réf.	W	€	Réf.	W	€	Réf.	W	€	Réf.	W	€
300	STR308W	316	180	STR310W	377	205	STR312W	459	210	STR316W	606	290	---	---	---
400	STR408W	363	185	STR410W	433	225	STR412W	527	198	STR416W	697	305	---	---	---
500	STR508W	430	190	STR510W	509	245	STR512W	621	200	STR516W	821	328	STR518W	943	350
600	STR608W	499	240	STR610W	589	270	STR612W	721	250	STR616W	952	390	STR618W	1094	401

## Les Kits Mixte

Couleur	Référence	W	€
Blanc	KIT500B	500	254
	KIT750B	750	256
	KIT1000B	1000	277
	KIT1250B	1250	290
Gris	KIT500G	500	287
	KIT750G	750	289
	KIT1000G	1000	310
	KIT1250G	1250	325



AUTRES MODELES  
VOIR PAGE 17



# CLASSICO 22

Sèche-Serviette

**KARTELL<sup>UC</sup>**

CHAUFFAGE

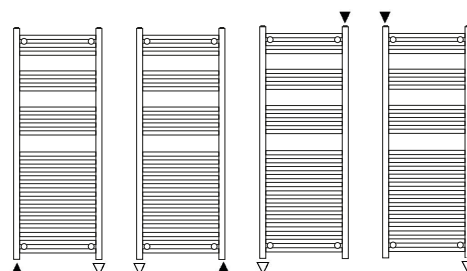
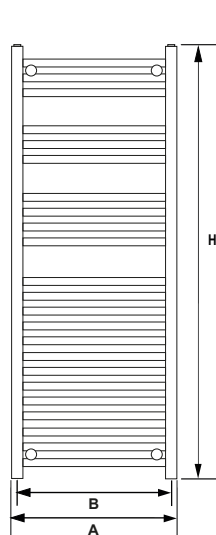
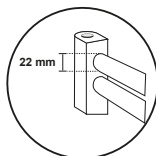

Profil Droit

Profil Courbé



A	B	C	D
300	255		
400	355		
500	455	83 / 96	68 / 81
600	555		

## Modèle Chromé - Droit

Hauteur (mm)	800			1000			1200			1600			1800			
	Largeur (mm)	Réf.	W	€	Réf.	W	€	Réf.	W	€	Réf.	W	€	Réf.	W	€
300		STR308C	222	195	STR310C	264	210	STR312C	322	220	STR316C	425	350	---	---	---
400		STR408C	255	201	STR410C	304	235	STR412C	370	250	STR416C	489	401	---	---	---
500		STR508C	302	210	STR510C	357	250	STR512C	436	260	STR516C	576	463	STR518C	662	545
600		STR608C	350	260	STR610C	413	285	STR612C	506	290	STR616C	668	495	STR618C	768	595

## Kit robinet décoratif



Chromé			
Thermostatique Equerre 1/2" complet Pour tube Cuivre 14 ou 16	Thermostatique Droit 1/2" complet Pour tube Cuivre 14 ou 16	Manuel Equerre 1/2" complet Pour tube Cuivre 14 ou 16	Manuel Droit 1/2" complet Pour tube Cuivre 14 ou 16
K850C-TH/Cu14 244,00 €	K851C-TH/Cu14 244,00 €	K850C-MN/Cu14 177,00 €	K851C-MN/Cu14 177,00 €
K850C-TH/Cu16 244,00 €	K851C-TH/Cu16 244,00 €	K850C-MN/Cu16 177,00 €	K851C-MN/Cu16 177,00 €
Blanc			
Thermostatique Equerre 1/2" complet Pour tube Cuivre 14 ou 16	Thermostatique Droit 1/2" complet Pour tube Cuivre 14 ou 16	Manuel Equerre 1/2" complet Pour tube Cuivre 14 ou 16	Manuel Droit 1/2" complet Pour tube Cuivre 14 ou 16
K850B-TH/Cu14 219,00 €	K851B-TH/Cu14 219,00 €	K850B-MN/Cu14 166,00 €	K851B-MN/Cu14 166,00 €
K850B-TH/Cu16 219,00 €	K851B-TH/Cu16 219,00 €	K850B-MN/Cu16 166,00 €	K851B-MN/Cu16 166,00 €

Sur demande : disponible pour tube Cuivre 12/18, P.E.R/P.E.X et Multicouche

# Robinetterie

## Radiateur chauffage central



Robinet Manuel Equerre MF

3/8" - 940N_10	<b>14,00 €</b>
1/2" - 940N_15	<b>15,00 €</b>
3/4" - 940N_20	<b>21,00 €</b>



Robinet Manuel Droit MF

3/8" - 941N_10	<b>14,00 €</b>
1/2" - 941N_15	<b>18,00 €</b>
3/4" - 941N_20	<b>25,00 €</b>



Robinet Manuel Equerre MM

3/8" - 945N_10	<b>14,00 €</b>
1/2" - 945N_15	<b>18,00 €</b>



Robinet Manuel Droit MM

3/8" - 946N_10	<b>15,00 €</b>
1/2" - 946N_15	<b>18,00 €</b>

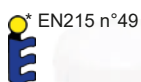

Robinet Thermostatique Equerre MF

3/8" - 760P_10	<b>18,00 €</b>
1/2" - 760P_15	<b>19,00 €</b>
3/4" - 760P_20	<b>26,00 €</b>

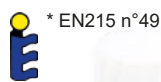

Robinet Thermostatique Droit MF

3/8" - 761P_10	<b>19,00 €</b>
1/2" - 761P_15	<b>21,00 €</b>
3/4" - 761P_20	<b>29,00 €</b>

Conforme à la norme EN 215



Robinet Thermostatique Equerre MM

3/8" - 770P_10	<b>18,00 €</b>
1/2" - 770P_15	<b>22,00 €</b>

Conforme à la norme EN 215



Robinet Thermostatique Droit MM

3/8" - 771P_10	<b>21,00 €</b>
1/2" - 771P_15	<b>24,00 €</b>



Coude de réglage MF

3/8" - 750N_10	<b>12,00 €</b>
1/2" - 750N_15	<b>13,00 €</b>
3/4" - 750N_20	<b>19,00 €</b>



Té de réglage MF

3/8" - 751N_10	<b>12,00 €</b>
1/2" - 751N_15	<b>13,00 €</b>
3/4" - 751N_20	<b>20,00 €</b>



Coude de réglage MM

3/8" - 755N_10	<b>10,00 €</b>
1/2" - 755N_15	<b>13,00 €</b>



Té de réglage MM

3/8" - 756N_10	<b>10,00 €</b>
1/2" - 756N_15	<b>13,00 €</b>



Adaptateur Cuivre

Ø14mm	
3525N_16x14	<b>7,20 €</b>



Adaptateur Cuivre Double étanchéité

Ø12mm	
3625N_16x12	<b>8,00 €</b>



Adaptateur P.E.R.

Ø12mm	
3015N_16x14	<b>10,30 €</b>



Adaptateur Multicouche

Ø16mm	
3015SCRN_16x16	<b>10,90 €</b>



Raccord S avec écrou tournant

10mm - RAC.S10	<b>22,00 €</b>
20mm - RAC.S20	<b>23,00 €</b>
30mm - RAC.S30	<b>24,00 €</b>



Douille de compensation avec écrou tournant

COMPENS-1/2	<b>17,00 €</b>
-------------	----------------

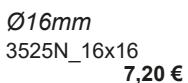

Adaptateur Cuivre

Ø16mm	
3625N_16x16	<b>8,00 €</b>

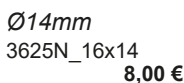

Adaptateur Cuivre Double étanchéité

Ø14mm	
3625N_16x14	<b>8,00 €</b>

Adaptateur Cuivre Double étanchéité Ø16mm

Ø16mm	
3625N_16x16	<b>8,00 €</b>



Tête Manuelle

0760P	<b>9,40 €</b>
-------	---------------



Tête Thermostatique

106CN	<b>32,80 €</b>
-------	----------------



Kit Robinet Manuel Décoratif - Cuivre Ø 14

Equerre KART-ANG	<b>68,00 €</b>
Droit KART-STR	<b>68,00 €</b>





Robinet thermostatisable avec canne et distributeur 4 voies avec bypass pour système monotube ou bitube

1/2" - 931 **86,00 €**



Robinet thermostatisable pour raccord monopoint avec canne d'injection verticale Ø11 x 10cm avec bypass pour système monotube ou bitube

1/2" - 960P **83,00 €**

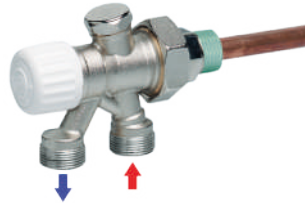

Robinet thermostatisable pour raccord monopoint avec canne d'injection horizontale Ø11 x 40cm avec bypass pour système monotube ou bitube

1/2" - 962 **63,00 €**



Adaptateur Cuivre

Ø18mm  
3525N\_18x18 **7,20 €**



Adaptateur Multicouche

Ø16mm  
3015SCRN\_18x16 **10,90 €**



Adaptateur Cuivre Double étanchéité

Ø12mm  
3625N\_18x12 **8,70 €**

Ø14mm  
3625N\_18x14 **8,70 €**

Ø16mm  
3625N\_18x16 **8,70 €**



Adaptateur P.E.R.

Ø12mm  
3015N\_18x12 **10,30 €**

Ø16mm  
3015N\_18x16 **10,30 €**



Vanne H thermostatisable orientable drainable avec bypass pour système monotube ou bitube - 3/4" MF

927 **121,00 €**



Distributeur H droit avec bypass pour système monotube ou bitube - 3/4" MF

915N **55,00 €**



Distributeur H Equerre avec bypass pour système monotube ou bitube - 3/4" MF

916N **55,00 €**



Adaptateur P.E.R.

Ø12mm  
3015N\_3/4"x12 **10,30 €**

Ø16mm  
3015N\_3/4"x16 **10,30 €**

Ø20mm  
3015N\_3/4"x20 **10,30 €**



Adaptateur Multicouche

Ø16mm  
3015SCRN\_3/4"x16 **12,80 €**

Ø20mm  
3015SCRN\_3/4"x20 **12,80 €**



Adaptateur Cuivre Double étanchéité

Ø12mm  
3625N\_3/4"x12 **10,10 €**

Ø14mm  
3625N\_3/4"x14 **10,10 €**

Ø16mm  
3625N\_3/4"x16 **10,10 €**

Ø18mm  
3625N\_3/4"x18 **10,10 €**



Adaptateur radiateur pour manchon 1/2"

0915SN **5,00 €**

Kit robinet DECOR thermostatisable Equerre - 1/2" M - 3/4" M



Chromé  
K850C **135,00 €**

Blanc  
K850B **135,00 €**

Kit robinet DECOR thermostatisable Droit - 1/2" M - 3/4" M



Chromé  
K851C **135,00 €**

Blanc  
K851B **135,00 €**

Tête Thermostatique



109LCRO **67,00 €**



109L **42,00 €**



Adaptateur Cuivre Double étanchéité

Chromé  
Ø14mm  
3625D\_3/4"x14 **21,00 €**

Ø16mm  
3625D\_3/4"x16 **21,00 €**



Adaptateur P.E.R.

Ø12mm  
3015D\_3/4"x12 **21,00 €**

Ø16mm  
3015D\_3/4"x16 **21,00 €**



Adaptateur Multicouche

Ø16mm  
3015SD\_3/4"x16 **21,00 €**

Blanc  
Ø14mm  
3625DB\_3/4"x14 **15,80 €**

Ø16mm  
3625DB\_3/4"x16 **15,80 €**

Ø12mm  
3015DB\_3/4"x12 **15,80 €**

Ø16mm  
3015DB\_3/4"x16 **15,80 €**

Ø16mm  
3015SDB\_3/4"x16 **15,80 €**

# Climatisation

## Monosplit mural



Plage de fonctionnement

- Classe énergétique A+++ et SEER de 6,1
- Gaz écologique R32
- Fonction I Feel
- Écran rétroéclairé
- Commande Wi-Fi de série
- Mode silencieux
- Redémarrage automatique intelligent
- Fonction Froid Turbo
- Protection Blue Fin
- Nettoyage automatique X-Fan
- Dégivrage intelligent
- Mode économie d'énergie
- Mode absence



Kit de raccordement complet



Accessoires

Référence	Puissance (F/C)	Ø Gaz / Liquide	Dimensions UI - UE	€ (dont DEEE)
<b>PULAR 9</b>	2500 / 2800 W	3/8" - 1/4"	704 / 260 / 185 - 732 / 555 / 330	<b>1190,24 (8,34)</b>
<b>PULAR 12</b>	3200 / 3400 W	3/8" - 1/4"	779 / 260 / 185 - 732 / 555 / 330	<b>1328,40 (8,34)</b>
<b>PULAR 18</b>	4600 / 5200 W	3/8" - 1/4"	982 / 311 / 221 - 732 / 555 / 330	<b>2230,49 (8,34)</b>
<b>PULAR 24</b>	6155 / 6448 W	5/8" - 1/4"	982 / 311 / 221 - 873 / 700 / 376	<b>2647,30 (8,34)</b>

Référence	Description	€
<b>Kit de Liaison frigorifique</b>		
<b>03KTIB1438M1</b>	Ø 3/8" - 1/4" - Longueur 3m	<b>100,26</b>
<b>06KTIB1438M1</b>	Ø 3/8" - 1/4" - Longueur 6m	<b>169,31</b>
<b>09KTIB1438M1</b>	Ø 3/8" - 1/4" - Longueur 9m	<b>239,75</b>
<b>03KTIB1458M1</b>	Ø 5/8" - 1/4" - Longueur 3m	<b>137,56</b>
<b>06KTIB1458M1</b>	Ø 5/8" - 1/4" - Longueur 6m	<b>241,05</b>
<b>09KTIB1458M1</b>	Ø 5/8" - 1/4" - Longueur 9m	<b>343,37</b>
<b>Accessoires divers</b>		
<b>AS465BTE</b>	Support mural suspendu réglable - Charge max. 90 kg	<b>32,68</b>
<b>AS400BMFPF</b>	Rubber foot - Support de sol - Longueur 40cm	<b>49,06</b>
<b>AS460TT</b>	Support de toiture - Charge max. 140 kg	<b>276,96</b>
<b>AP01</b>	Pompe de relevage de condensat	<b>158,62</b>
<b>AP06</b>	Pompe de relevage de condensat sous goutlotte	<b>182,22</b>



# Climatisation Multisplit mural

CHAUFFAGE

Plage de  
fonctionnement



- Jusqu'à 5 unités intérieures (nous consulter)
- Classe énergétique A++/A+
- Haute efficacité
- Large plage de fonctionnement
- Technologie G10 Inverter de Gree
- Consommation ultra-basse en StandBy
- Faible niveau sonore
- Confort accru
- Fonctionnement sur une large plage de tension
- Redémarrage automatique

## 8 COMBINAISONS



	2 UNITÉS	
	7+7	9+9
9	7+9	9+12
12	7+12	12+12



## 88 COMBINAISONS

FM 36	3 UNITÉS			4 UNITÉS		
7+7+7	7+18+18	9+18+21	7+7+7+7	7+7+18+18	9+9+9+9	
7+7+9	7+18+21	9+18+24	7+7+7+9	7+7+18+21	9+9+9+12	
7+7+12	7+18+24	9+21+21	7+7+7+12	7+9+9+9	9+9+9+18	
7+7+18	7+21+21	9+21+24	7+7+7+18	7+9+9+12	9+9+9+21	
7+7+21	7+21+24	12+12+12	7+7+7+21	7+9+9+18	9+9+9+24	
7+7+24	9+9+9	12+12+18	7+7+7+24	7+9+9+21	9+9+12+12	
7+9+9	9+9+12	12+12+21	7+7+9+9	7+9+9+24	9+9+12+18	
7+9+12	9+9+18	12+12+24	7+7+9+12	7+9+12+12	9+9+12+21	
7+9+18	9+9+21	12+18+18	7+7+9+18	7+9+12+18	9+9+12+24	
7+9+21	9+9+24	12+18+21	7+7+9+21	7+9+12+21	9+9+18+18	
7+9+24	9+12+12	12+18+24	7+7+9+24	7+9+12+24	9+12+12+12	
7+12+12	9+12+18	12+21+21	7+7+12+12	7+9+18+18	9+12+12+18	
7+12+18	9+12+21	18+18+18	7+7+12+18	7+12+12+12	9+12+12+21	
7+12+21	9+12+24	-	7+7+12+21	7+12+12+18	12+12+12+12	
7+12+24	9+18+18	-	7+7+12+24	7+12+12+21	12+12+12+18	

## 23 COMBINAISONS



	2 UNITÉS		3 UNITÉS	
	7+7	9+12	7+7+7	7+12+12
	7+9	9+18	7+7+9	9+9+9
	7+12	12+12	7+7+12	9+9+12
	7+18	12+18	7+7+18	9+9+18
	9+9	18+18	7+9+9	9+12+12
	-	-	7+9+12	12+12+12
	-	-	7+9+18	-

### Unité intérieure

Référence	Puissance (F/C)	Ø Gaz / Liquide	Dimensions UI	€ (dont DEEE)
<b>FM PULAR 7</b>	2200 / 2400 W	3/8" - 1/4"	704 / 260 / 185	<b>404,54 (1,67)</b>
<b>FM PULAR 9</b>	2500 / 2800 W	3/8" - 1/4"	704 / 260 / 185	<b>439,72 (1,67)</b>
<b>FM PULAR 12</b>	3200 / 3400 W	3/8" - 1/4"	779 / 260 / 185	<b>471,88 (1,67)</b>
<b>FM PULAR 18</b>	4600 / 5200 W	3/8" - 1/4"	982 / 311 / 221	<b>637,90 (1,67)</b>
<b>FM PULAR 24</b>	6155 / 6448 W	5/8" - 1/4"	982 / 311 / 221	<b>845,72 (1,67)</b>

### Groupe extérieur

Référence	Puissance (F/C)	Ø Gaz / Liquide	Dimensions UE	€ (dont DEEE)
<b>FM 18</b>	5300 / 5650 W	2 x 3/8" - 2 x 1/4"	745 / 550 / 300	<b>1825,71 (6,67)</b>
<b>FM 24</b>	7100 / 8600 W	3 x 3/8" - 3 x 1/4"	889 / 654 / 340	<b>2621,24 (6,67)</b>
<b>FM 36</b>	10600 / 12000 W	4 x 3/8" - 4 x 1/4"	1020 / 825 / 427	<b>3719,55 (6,67)</b>

# ***NOTE***

---

---

---

---

---

---

---

---

---

---

---

---

---

---

---

---

---

---

---

---

---

---

---

---

---

---

---

---

# Les autres catalogues

Sanitaire



Radiateur décoratif



Receveur électrique

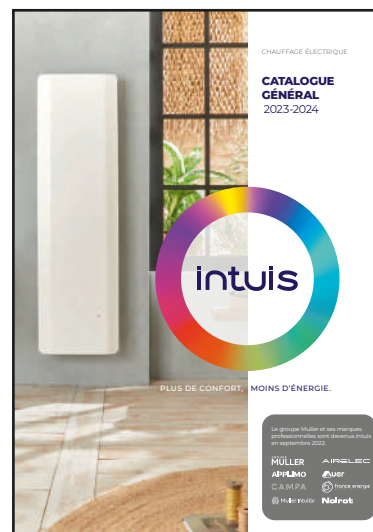

Radiateur en Fonte



Radiateur décoratif





S.A.R.L S.M.T.A

9 Rue de la Victoire  
93150 Le Blanc-Mesnil

Tel / Fax : 01 48 60 66 84

[infos@societe-smta.fr](mailto:infos@societe-smta.fr) / [societe.smta@gmail.com](mailto:societe.smta@gmail.com)

[www.societe-smta.fr](http://www.societe-smta.fr)

#### CONTACT COMMERCIAL

Mme PEREMANS Mélanie

07 83 06 65 79

[m.peremans@societe-smta.fr](mailto:m.peremans@societe-smta.fr)



@societe.smta

#### Horaires d'ouverture

du Lundi au Jeudi  
de 8h à 12h et de 13h30 à 17h  
le Vendredi

de 8h à 12h et de 13h30 à 16h